

Lenses for Digital Photography



Lenses optimized for digital technology
for adjustable professional cameras
with digital area sensor or scan backs

Note:

This brochure can also be downloaded as a PDF file from our website. Then all underlined links can be used for faster navigation; unfortunately, in the printed document the links do not work.

Photo Optics – digital and analog

These are some of the typical fields of application for our photo lenses, quality filters and aspherical magnifiers:

- Professional digital photography with high-resolution CCD line scanner backs and CCD/CMOS chip backs attached to technical cameras for perspective control by parallel shifts and/or extended depth of field by swing and tilt according to the Scheimpflug law as well as for industrial applications.
- Professional medium and large format photography with technical cameras for perspective control by parallel shifts and/or extended depth of field by swing and tilt.
- Industrial applications with CCD cameras, particularly for measuring and examination as well as for identification.
- Blocking of impairing UV and/or IR radiation, attenuation of bright light, reduction or avoidance of reflexions, correction of colors or their rendition in grey tones by optical filters.
- Quality control of slides, transparencies, negatives, photographic enlargements and proof prints with distortion free aspherical magnifiers that provide best sharpness and are free from color fringes.

This brochure describes our products for the first mentioned field of application "digital photography". For all other products please visit our website as given below in the last line.

Rodenstock Photo Optics is the right partner for you for all these applications when you need standard optics, technical support and advice or if your application requests a customized development. Please contact us ...

... if you need additional technical information,
... if you need technical support or
... if you need a customized solution.

For orders or if there are questions about availability or prices of our standard series products, please contact our local distributor(s) directly. You can find an address list with our distributors in Germany and in many other countries in Europe and overseas on our website: <http://www.rodenstock-photo.com>



- ▶ [HR Digaron-S](#)
- ▶ [HR Digaron-W/SW](#)
- ▶ [Apo-Sironar digital](#)
- ▶ [Apo-Macro-Sironar digital](#)

- ▶ [Accessories: Centerfilter](#)
- ▶ [Accessories: Focus-Mount](#)

Lenses for Digital Professional Photography

Digital photography with current lenses, cameras and digital backs is superior to conventional photography in almost every case: Digital photography is faster, cheaper for high photo quantities, it makes retouching easier, allows more effective manipulation and may have a higher quality. Furthermore, the results (digital files) can be transferred across largest distances extremely fast and cheap via the internet. However, it makes much higher demands on the image rendering quality of the lens because of the special technical requirements of the sensors (e.g. regular pixel grid, planar sensor surface and a 2 mm thick protective and filter glass plate in front of it) if the theoretically possible quality increase is to be realized in practice.

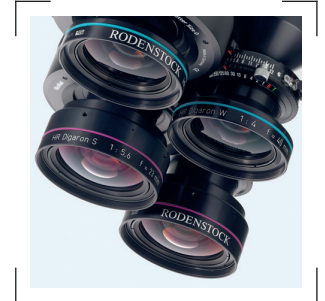

Lenses for adjustable technical cameras must offer really large image angles for perspective controls and lens swing and tilt and must ensure the very best imaging quality right up to their image circle margin. The resolving power and the contrast must be at their optimum even at large apertures (f/8, when used with relatively small area sensors even from f/5.6) to ensure that diffraction and color noise do not impair sharpness. Furthermore, the correction of curvature of field has to meet the highest demands because of the virtually perfectly planar sensor surface, and the lenses may not generate any color fringes or any visible distortion. All these demands are met by the Rodenstock lenses HR Digaron-S, HR Digaron-W/SW, Apo-Sironar digital and Apo-Macro-Sironar digital.

- The HR Digaron-S lenses provide extremely high resolution already from open aperture, perfectly corrected image curvature and a correction for the thickness of the sensor's protective glass. They are the best lenses for smaller sensors up to 33x44 mm or (if no large shift is necessary) even up to 37x49 mm with a pixel pitch around 5 μm or even smaller.
- The HR Digaron-W/SW lenses with a little bit smaller working aperture (optimum: f/5.6 to f/8 or f/8 to f/11) and a larger image circle diameter for sensors up to 40x54 mm provide almost the same extraordinary characteristics.
- Both lens series Apo-Sironar digital and Apo-Macro-Sironar digital (the latter is optimized for close ups) provide large image circles for substantial camera movements with digital scan backs and with chip backs being used in the macro-scan mode for larger formats by stitching multiple shots made with laterally shifted back from one shot to the next. Resolving power is designed for a pixel pitch down to 9 μm .

Rodenstock lenses provide you with best sharpness for highest resolution line scanners and area sensors in order to get the full potential from this technology

◀ [Back to digital photography](#)

- ▶ [HR Digaron-S](#)
- ▶ [HR Digaron-W/SW](#)
- ▶ [Apo-Sironar digital](#)
- ▶ [Apo-Macro-Sironar digital](#)

- ▶ [Accessories: Centerfilter](#)
- ▶ [Accessories: Focus-Mount](#)

Lenses for Digital Professional Photography

HR Digaron-S

The Rodenstock HR Digaron-S lens series was developed for special applications with extremely high resolution CCD chip backs with a pixel pitch around 5 µm or noticeable smaller. These lenses utilize every technological possibility to get as close as possible to the absolute physical limit of diffraction-determined resolution. Among other things, even the optical properties and the thickness of the CCD protective glass were taken into the equation of the optical correction.

The resolving power and lateral chromatic aberration have been optimized to ensure that the resulting lack of sharpness or the color fringes do not amount to any more than a tiny fraction of the pixel size (which can no longer be resolved). As a result, even when the digital photos taken with the lens are enlarged to a maximum on the screen, absolutely no color fringes are visible, unless color fringes are added by the pixel structure of the sensor's Bayer filter or due to interpolation.

The resolving power of the HR Digaron-S is not only a little better for the working apertures of f/8 to f/11 recommended for other high-performance lenses. You can rather see an increase in performance even with a higher aperture right up to the maximum at f/5.6 to f/4. This increase is reflected in the very high brilliance and detail reproduction. To ensure that this fantastic quality is not impaired by diffraction, HR lenses should always be stopped down as little as possible. This means that the depth of field should be increased for motifs extended in depth by using an optimum lens tilt for an overall sharp focus.

The advantageous larger apertures available with these lenses also reduce color noise in the shadows.



Data sheets

- ▶ [Formats, dimensions, shutter data, image circles, movement ranges](#)
- ▶ [Performance data HR Digaron-S 23 mm f/5,6](#)
- ▶ [Performance data HR Digaron-S 28 mm f/4,5](#)
- ▶ [Performance data HR Digaron-S 35 mm f/4](#)
- ▶ [Performance data HR Digaron-S 60 mm f/4](#)
- ▶ [Performance data HR Digaron-S 100 mm f/4](#)
- ▶ [Performance data HR Digaron-S 180 mm f/5,6](#)

HR Digaron-S	Max. recommended sensor format	
23 mm f/5.6	33×44 mm	(37×49 mm *)
28 mm f/4.5	33×44 mm	(37×49 mm *)
35 mm f/4	33×44 mm	(37×49 mm *)
60 mm f/4	33×44 mm	(37×49 mm *)
100 mm f/4	33×44 mm	(37×49 mm *)
180 mm f/5.6	37×49 mm	

* Reduced movements available with this larger sensor format

Apo-Sironar digital HR: the optimum with a superior reserve in sharpness for high resolution digital backs

HR Digaron-S
[◀ Back to lens description](#)
Formats, shutter sizes, dimensions, weight

Lens	Maximum sensor format	Shutter size	Push-on mount Ø (a)	Filter thread (b)	Rear barrel Ø (c)	Flange foc. length ¹⁾ (d)	Flange to lens end (e)	Overall length (f)	Weight with Copal
23 mm f/5.6	33×44 mm	0	75 mm	M 72×0.75	48.0 mm	44.8 mm	28.8 mm	89.6 mm	580 g
28 mm f/4.5	33×44 mm	0	75 mm	M 72×0.75	48.0 mm	53.1 mm	36.7 mm	105.5 mm	830 g
35 mm f/4	33×44 mm	0	70 mm	M 67×0.75	48.0 mm	53.5 mm	29.2 mm	80.4 mm	480 g
60 mm f/4	33×44 mm	0	51 mm	M 49×0.75	42.0 mm	64.3 mm	24.0 mm	57.6 mm	240 g
100 mm f/4	33×44 mm	0	60 mm	M 58×0.75	42.0 mm	99.8 mm	22.1 mm	73.4 mm	370 g
180 mm f/5.6	37×49 mm	0	70 mm	M 67×0.75	60.0 mm	177.4 mm	40.6 mm	90.3 mm	425 g

¹⁾ With Copal shutter for scale 1:∞

All lenses of the HR Digaron-S series are available not only with the shutters given in the following table, but also with a normal mount (with 39 mm Leica thread) or alternatively with the "Focus-Mount" helical focuser.

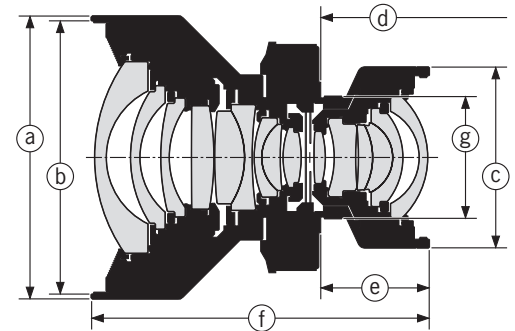
Focusing range and flange focal length with Focus-Mount

Lens	Focusing range	Flange foc. length ¹⁾ (d)	Max. flange to lens end (e)
23 mm f/5.6	∞ – 0.25 m / 0.8 ft	26.1 mm	10.1 mm
28 mm f/4.5	∞ – 0.3 m / 1.0 ft	34.4 mm	18.0 mm
35 mm f/4	∞ – 0.4 m / 1.3 ft	34.8 mm	10.5 mm
60 mm f/4	∞ – 0.7 m / 2.0 ft	45.6 mm	5.3 mm
100 mm f/4	∞ – 1.8 m / 6.0 ft	80.1 mm	3.4 mm
180 mm f/5.6	∞ – 4.0 m / 13.0 ft	158.7 mm	21.9 mm

Using digital lenses on cameras without bellows such as shift or panoramic cameras requires the use of a focusing facility. For this purpose, the Focus-Mount can be combined with all Rodenstock lenses in Copal shutter size 0. Existing lenses can be installed at a later date by the manufacturer.

¹⁾ With Copal shutter for scale 1:∞

[▶ Continuation performance data](#)
Shutter data

Shutter type and size	Shutter speeds range	Manual cocking	Self cocking	Mechanical	Electronic	X-synchronized	Smallest f-stop increments	Screw thread (g)	Lens board opening	Lens board thickness	Accessories required
Copal 0	B, T, 1/500 s ... 1 s	•	•	•	•	•		M 32.5×0.5	34.8 mm	1.5 ... 4 mm	
Rodenst. eShutter 0	T, 1/125 s ... 32 s				•	•	1/6	M 32.5×0.5	34.8 mm	1.5 ... 4 mm	eShutter Control
Rollei Electron. 0	B, 1/500 s ... 30 s				•	•	1/10	M 39×0.75	41.8 mm	1.5 ... 3 mm	Control Unit

These lenses provide outstanding image quality thanks to a refined lens design with a large number of lens elements

HR Digaron-S

[◀ Back to lens description](#)

Working apertures, image angles, image circles and movement ranges

Lens	Ref. Image scale	Recomm. Working f-stop	Image angle	Image circle diameter	Movement range [mm] ² vertical/horizontal (landscape format)					
					24x36 mm	37x37 mm	33x44 mm	37x49 mm	36x56 mm	40x54 mm
23 mm f/5.6	1:∞	5.6-8	112°	70 mm	18 / 15	11 / 11	11 / 9	7 / 5	3 / 2	2 / 2
28 mm f/4.5	1:∞	5.6-8	101°	70 mm	18 / 15	11 / 11	11 / 9	7 / 5	3 / 2	2 / 2
35 mm f/4	1:∞	5.6	90°	70 mm	18 / 15	11 / 11	11 / 9	7 / 5	3 / 2	2 / 2
60 mm f/4	1:∞	5.6	60°	70 mm	18 / 15	11 / 11	11 / 9	7 / 5	3 / 2	2 / 2
100 mm f/4	1:∞	5.6	39°	70 mm	18 / 15	11 / 11	11 / 9	7 / 5	3 / 2	2 / 2
180 mm f/5.6	1:∞	5.6-8	25°	80 mm	24 / 20	17 / 17	17 / 14	13 / 11	11 / 8	9 / 8

²⁾ These values apply to the recommended working aperture at the given scale; with increasing scale, image circle and movement ranges increase

Image circles (original size)

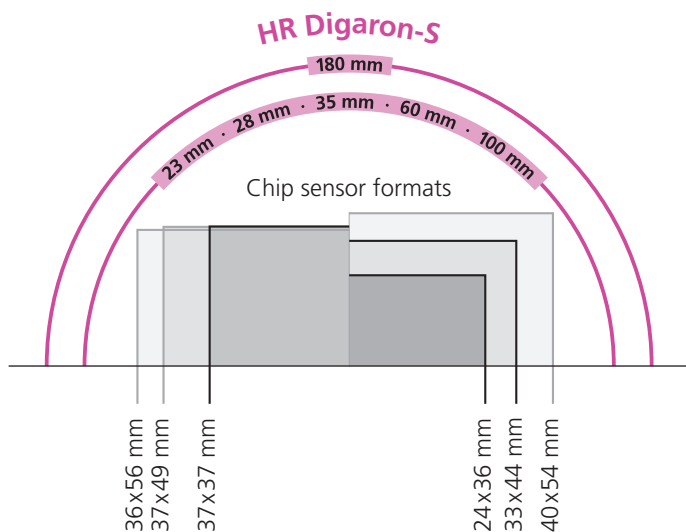

The lenses HR Digaron-S with focal lengths up to 100 mm are recommended for use with sensor formats of 37x49 mm or larger only if no larger camera movements are needed.

If larger camera movements are needed for correcting converging lines or for lens swing and tilt (according to the Scheimpflug rule) with sensor formats of 37x49 mm or larger then the new line of Rodenstock lenses HR Digaron-W/SW with image circle diameters from 90 mm upwards should be used.

The large image circle allows large camera movements with all current sensor formats at least up to 33x44 mm

HR Digaron-S 23 mm f/5.6

[◀ Back to lens description](#)

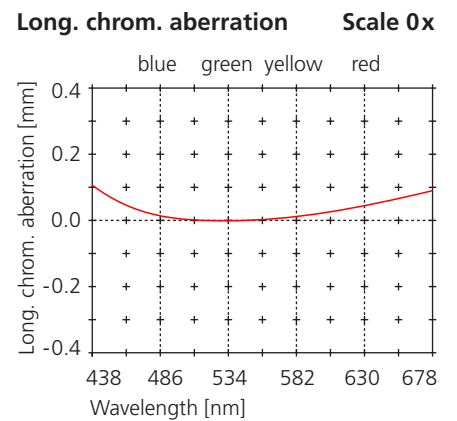
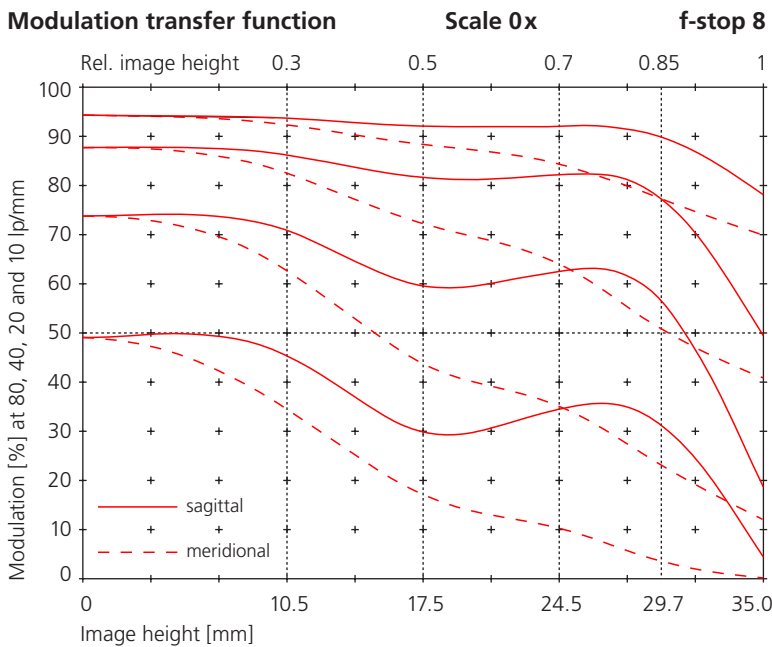
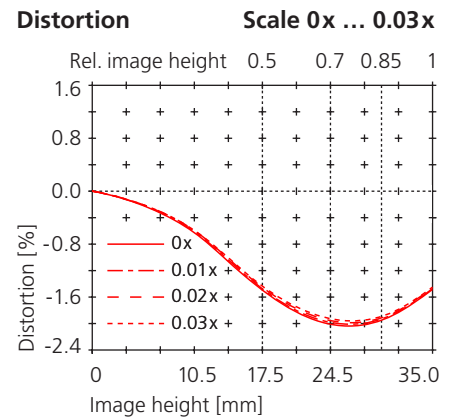
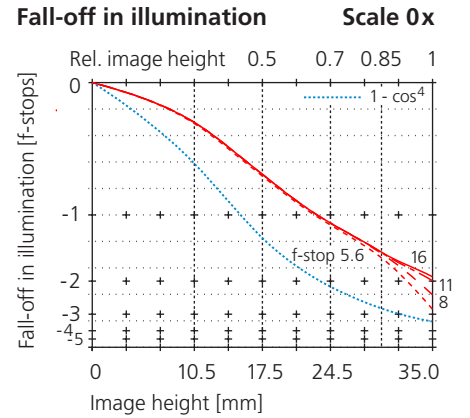
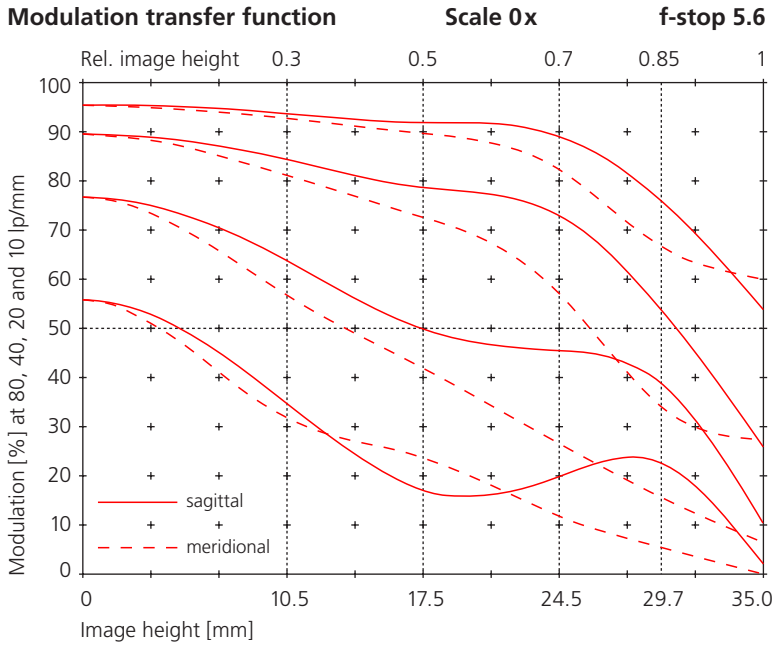

All spatial frequencies [line pairs/mm], image heights [mm] and scales are related to the film or sensor side

HR Digaron-S 28 mm f/4.5

[◀ Back to lens description](#)

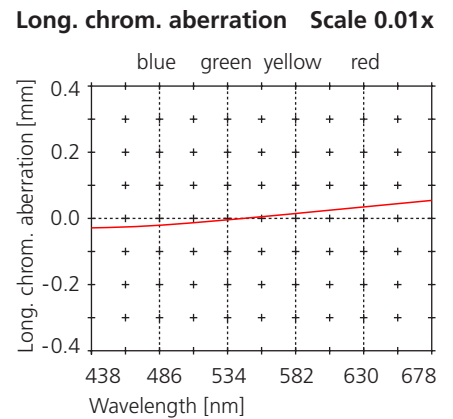
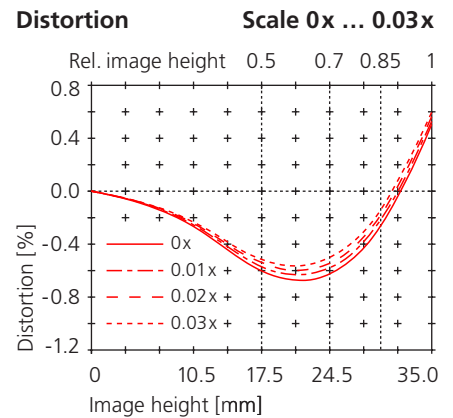
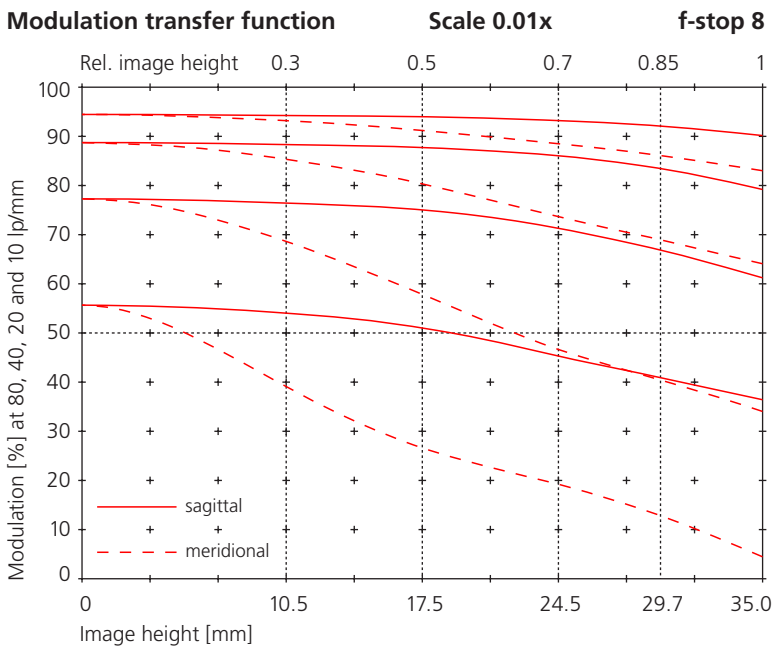
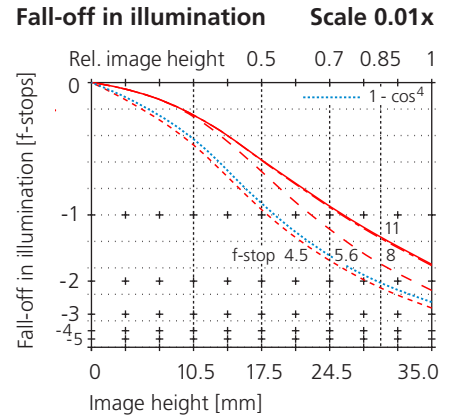
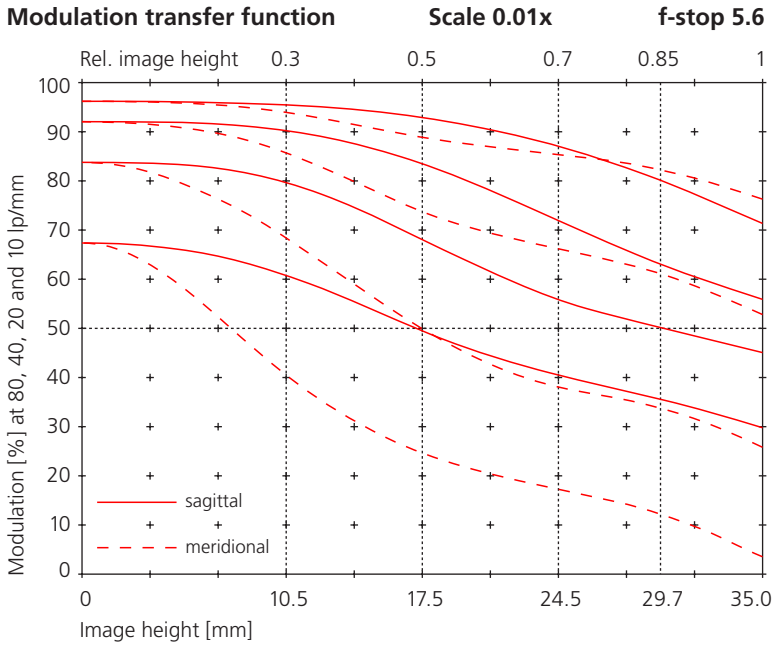

All spatial frequencies [line pairs/mm], image heights [mm] and scales are related to the film or sensor side

HR Digaron-S 35 mm f/4

[◀ Back to lens description](#)

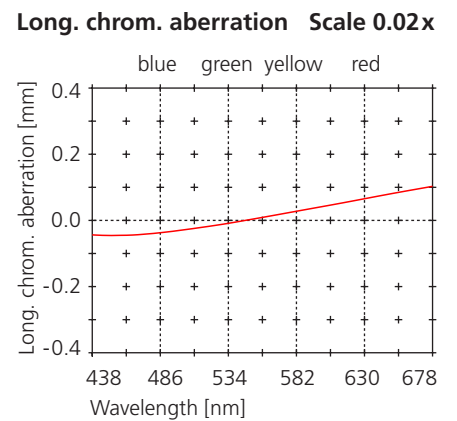
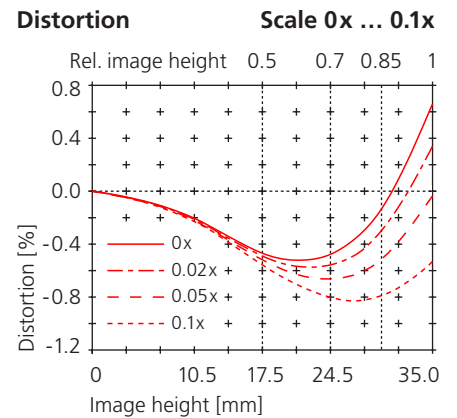
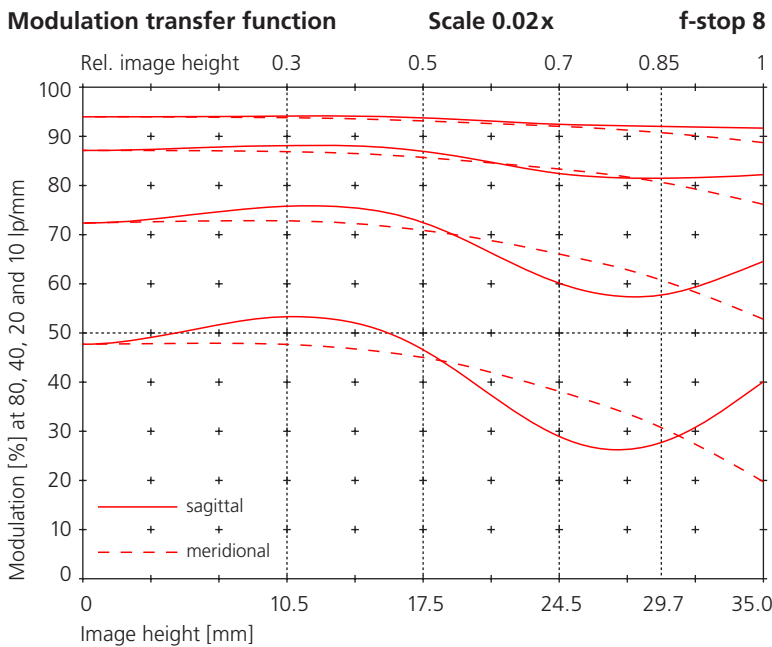
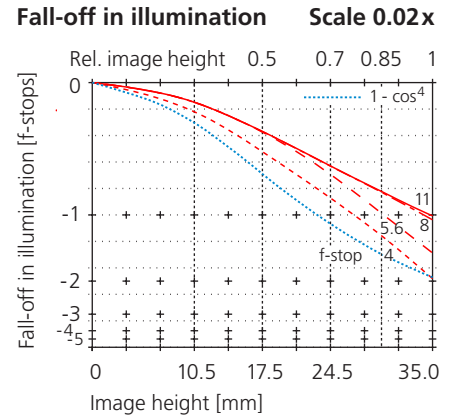
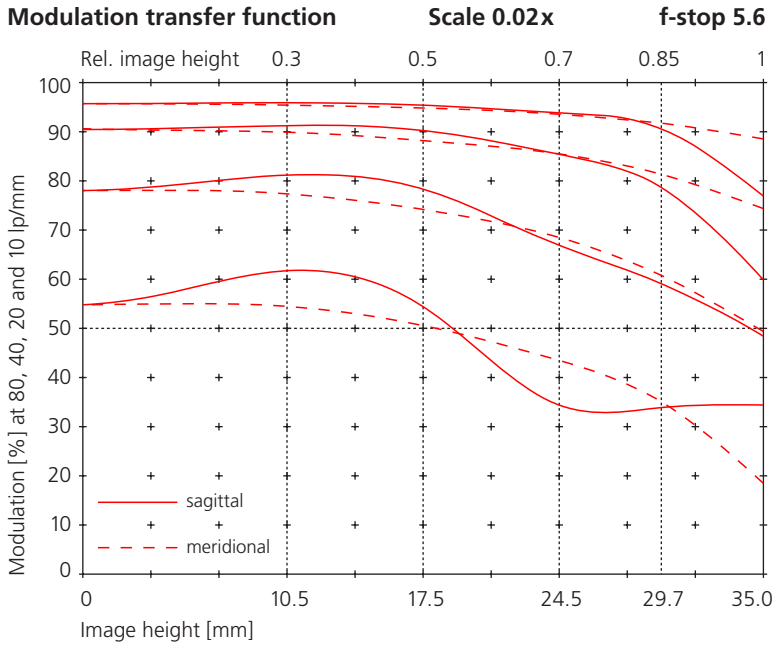

All spatial frequencies [line pairs/mm], image heights [mm] and scales are related to the film or sensor side

HR Digaron-S 60 mm f/4

[◀ Back to lens description](#)

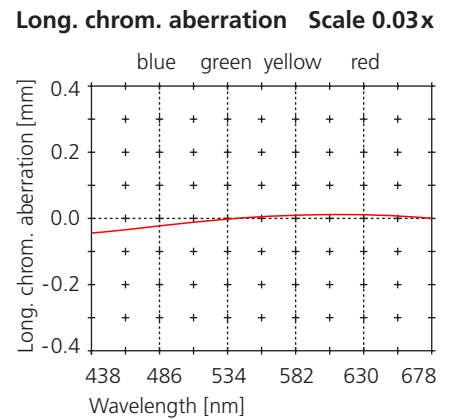
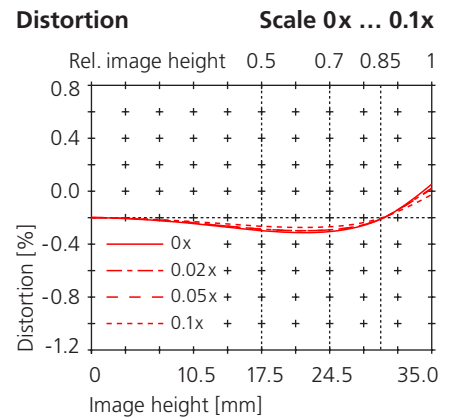
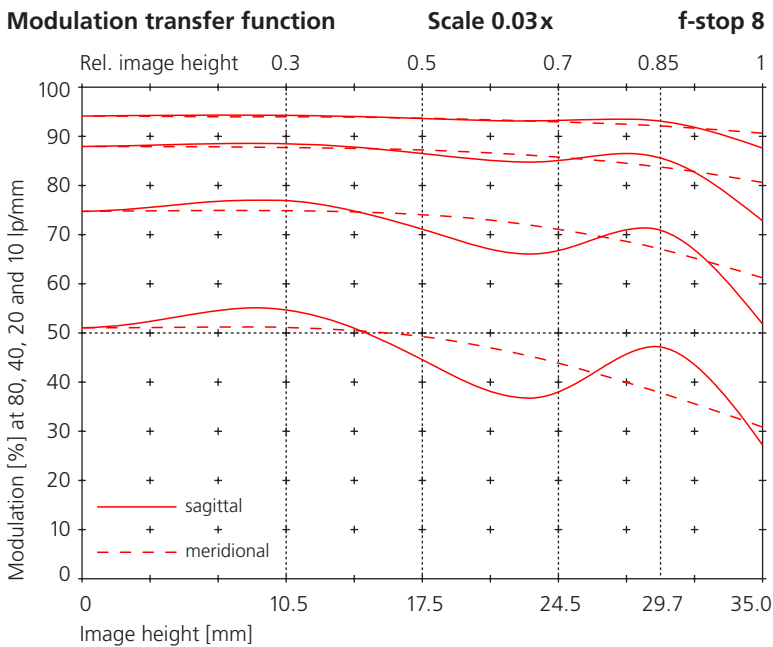
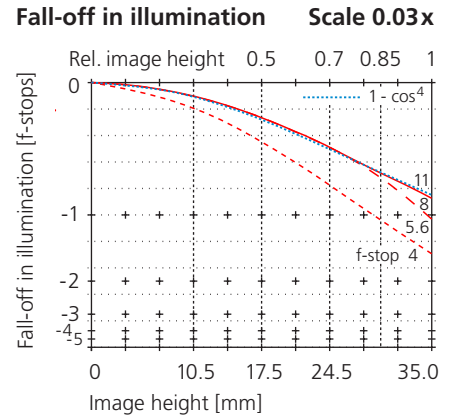
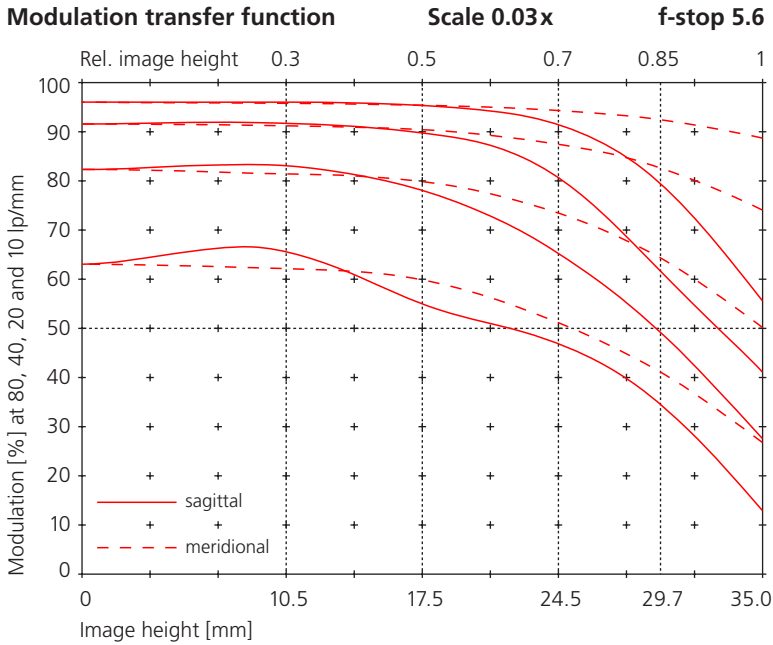

All spatial frequencies [line pairs/mm], image heights [mm] and scales are related to the film or sensor side

HR Digaron-S 100 mm f/4

[◀ Back to lens description](#)

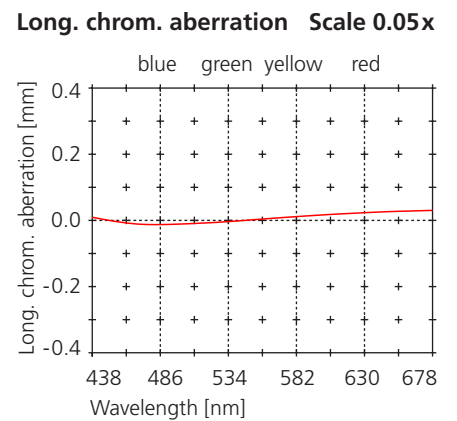
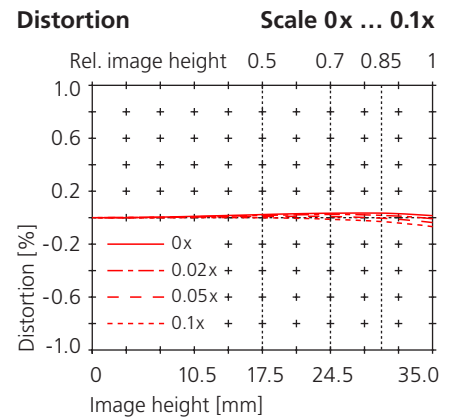
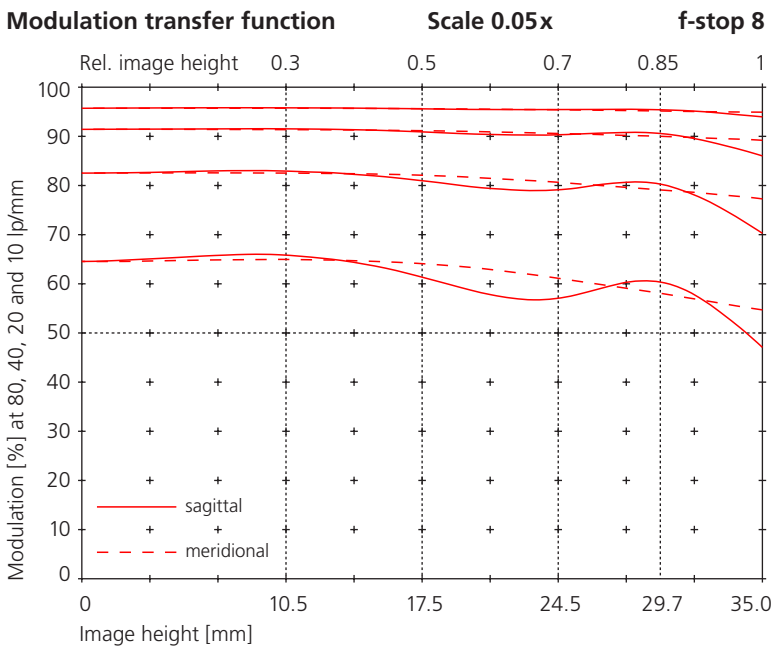
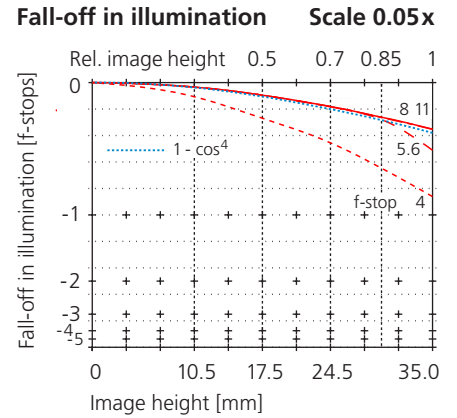
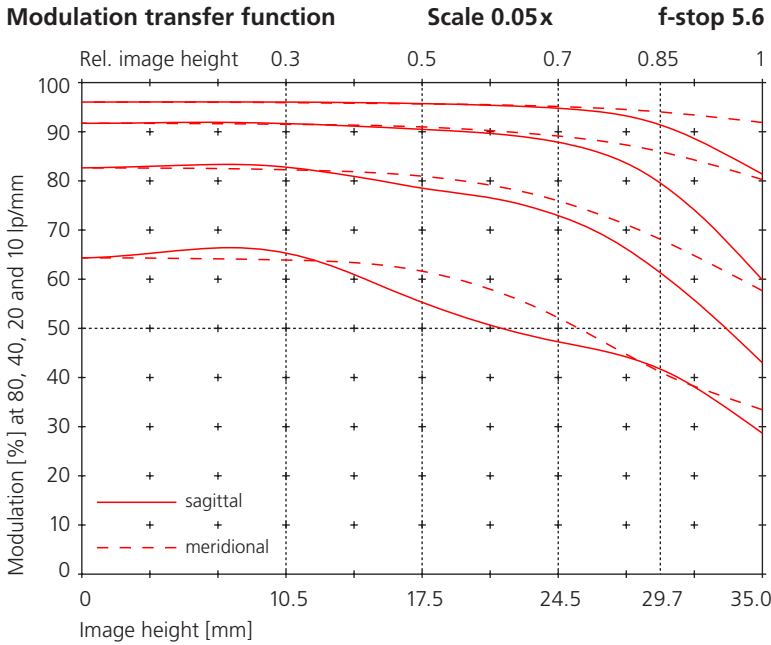

All spatial frequencies [line pairs/mm], image heights [mm] and scales are related to the film or sensor side

HR Digaron-S 180 mm f/5.6

[◀ Back to lens description](#)

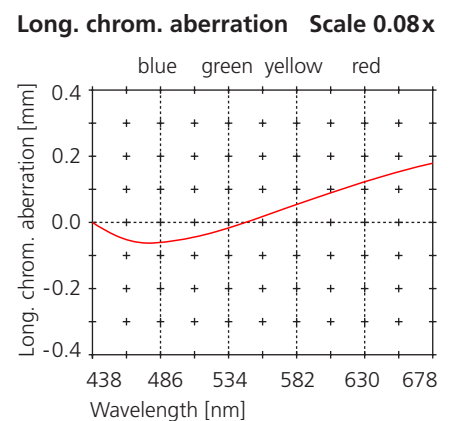
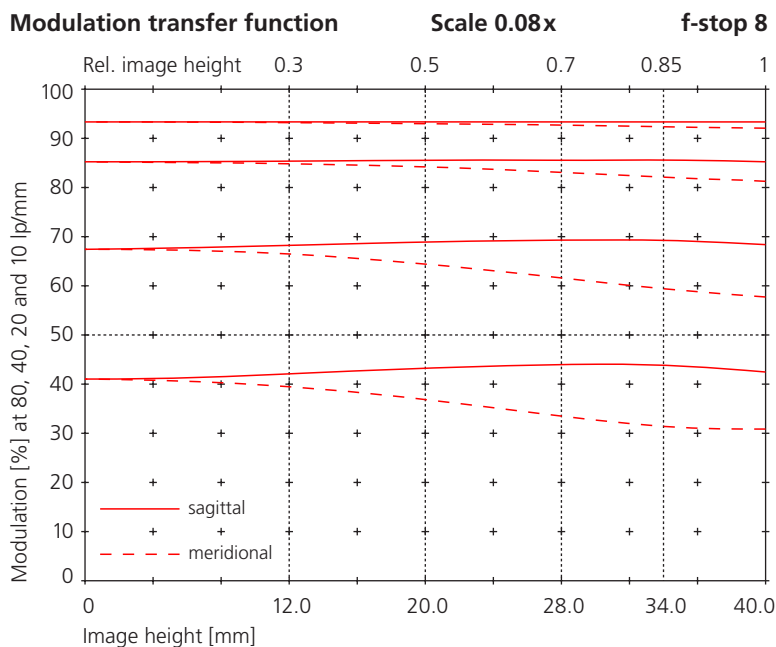
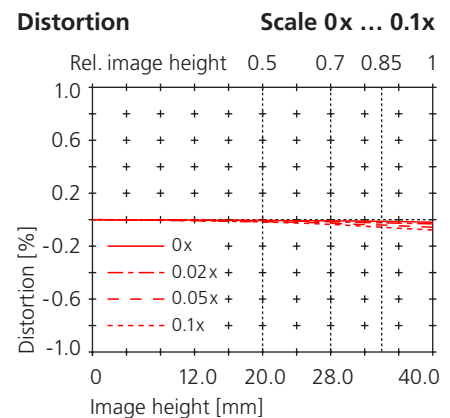
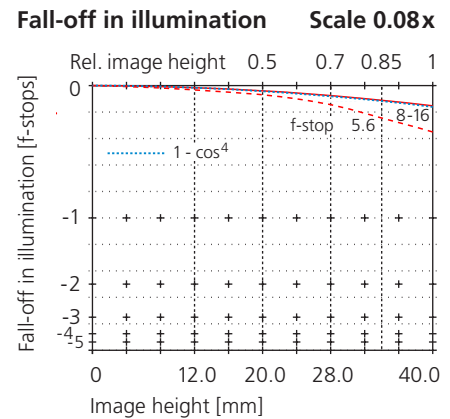
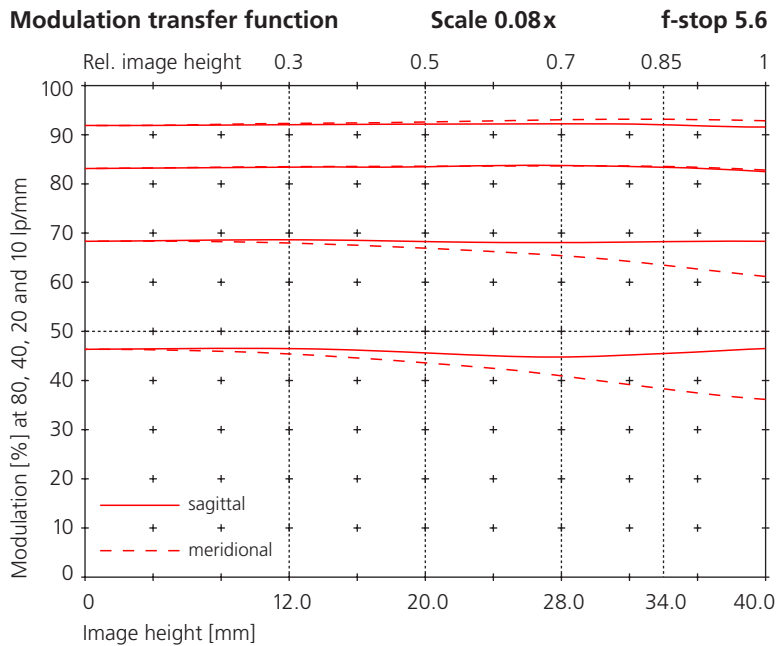

All spatial frequencies [line pairs/mm], image heights [mm] and scales are related to the film or sensor side

◀ [Back to digital photography](#)

- ▶ [HR Digaron-S](#)
- ▶ **[HR Digaron-W/SW](#)**
- ▶ [Apo-Sironar digital](#)
- ▶ [Apo-Macro-Sironar digital](#)

- ▶ [Accessories: Centerfilter](#)
- ▶ [Accessories: Focus-Mount](#)

Lenses for Digital Professional Photography

HR Digaron-W/SW

The pixel size of the sensors of digital camera backs cannot be reduced just as one likes for achieving higher resolution without a significant increase of image noise and a reduction of exposure latitude. This is the reason why larger sensors have been developed for professional digital backs. However, digital lenses with image circle diameters of about 70 mm designed for smaller sensors do not allow sufficient camera movements. This is why the new Rodenstock lens series HR Digaron-W/SW with larger image circles from 90 mm on and with an extremely high resolution (very close to the physical limit of diffraction) has been developed. This new lens series comprises the focal lengths of 32 mm, 40 mm, 50 mm, 70 mm and 90 mm.

The wide angle of view of the short focal length lenses causes larger light incident angles at the margin of the image. This could result in some blur because of astigmatism, spherical aberration and color fringes produced by the protection glass of a thickness of approx. 2 mm in front of the light-sensitive sensor plane. This can be visible with high resolution sensors. Therefore, the optical effects of this glass plate have been taken into consideration for the calculation of all lenses.

A remarkable feature of the HR Digaron-W 32 mm f/4 and 40 mm f/4 (focal lengths equivalent to 20.6 mm and 26.5 mm for 35 mm format) is the long back focal length of 22.3 mm and 25 mm respectively. It leaves free space for shift and tilt movements between the rear mount and the sensor to avoid touching it or the rear standard. A flange focal length of approx. 70 mm allows focusing at infinity with a flat lens board and permits the use of the larger Rollei Electronic shutter.



Data sheets

- ▶ [Formats, dimensions, shutter data, image circles, movement ranges](#)
- ▶ [Performance data HR Digaron-W 32 mm f/4](#)
- ▶ [Performance data HR Digaron-W 40 mm f/4](#)
- ▶ [Performance data HR Digaron-W 50 mm f/4](#)
- ▶ [Performance data HR Digaron-W 70 mm f/5.6](#)
- ▶ [Performance data HR Digaron-SW 90 mm f/5.6](#)

HR Digaron-W/SW	Max. recommended sensor format
32 mm f/4	40×54 mm
40 mm f/4	40×54 mm
50 mm f/4	40×54 mm
70 mm f/5.6	54×74 mm (Stitch format)
90 mm f/5.6	54×74 mm (Stitch format)

HR Digaron-W/SW: after all, we can really take advantage of the extremely high resolution of the new large sensors

Rodenstock Photo Optics

a brand of Qioptiq Photonics GmbH & Co. KG

HR Digaron-W/SW

[◀ Back to lens description](#)

Formats, shutter sizes, dimensions, weight

Lens	Maximum sensor or stitch format	Shutter size	Push-on mount Ø (a)	Filter thread (b)	Rear barrel Ø (c)	Flange foc. length ¹⁾ (d)	Flange to lens end (e)	Overall length (f)	Weight with Copal
32 mm f/4	40×54 mm	0	90 mm	M 86×1.0	56.0 mm	69.2 mm	46.9 mm	113.2 mm	795 g
40 mm f/4	40×54 mm	0	70 mm	M 67×0.75	56.0 mm	69.5 mm	44.4 mm	96.4 mm	530 g
50 mm f/4	40×54 mm	0	70 mm	M 67×0.75	51.0 mm	76.0 mm	44.3 mm	98.4 mm	550 g
70 mm f/5.6	54×74 mm	0	60 mm	M 58×0.75	48.0 mm	72.7 mm	23.6 mm	72.8 mm	340 g
90 mm f/5.6	54×74 mm	0	75 mm	M 72×1.0	56.0 mm	109,4 mm	42,7 mm	107.0 mm	680 g

¹⁾ With Copal shutter for scale 1:∞

All lenses of the HR Digaron-W/SW series are available not only with the shutters given in the following table, but also with a normal mount (with 39 mm Leica thread) or alternatively with the "Focus-Mount" helical focuser.

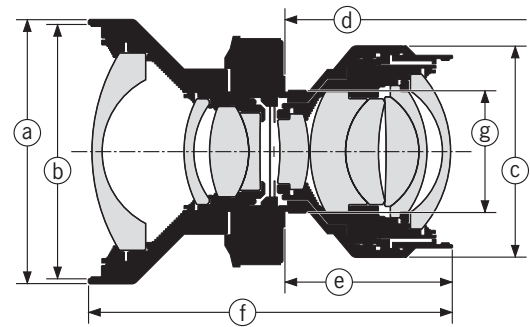

Focusing range and flange focal length with Focus-Mount

Lens	Focusing range	Flange foc. length ¹⁾ (d)	Max. flange to lens end (e)
32 mm f/4	∞ – 0.4 m / 1.2 ft	50.5 mm	28.2 mm
40 mm f/4	∞ – 0.5 m / 1.6 ft	50.8 mm	25.7 mm
50 mm f/4	∞ – 0.8 m / 2.6 ft	57.3 mm	25.6 mm
70 mm f/5.6	∞ – 0.8 m / 2.6 ft	54.0 mm	4.9 mm
90 mm f/5.6	∞ – 1.3 m / 5.0 ft	90,7 mm	24.0 mm

Using digital lenses on cameras without bellows such as shift or panoramic cameras requires the use of a focusing facility. For this purpose, the Focus-Mount can be combined with all Rodenstock lenses in Copal shutter size 0. Existing lenses can be installed at a later date by the manufacturer.

¹⁾ With Copal shutter for scale 1:∞

[▶ Continuation performance data](#)

Shutter type and size	Shutter speeds range	Shutter data					Screw thread (g)	Lens board opening	Lens board thickness	Accessories required
		Manual cocking	Self cocking	Mechanical	Electronic	X-synchronized				
Copal 0	B, T, 1/500 s ... 1 s	•	•				M 32.5×0.5	34.8 mm	1.5 ... 4 mm	
Rodenst. eShutter 0	T, 1/125 s ... 32 s				•	•	M 32.5×0.5	34.8 mm	1.5 ... 4 mm	eShutter Control
Rollei Electron. 0	B, 1/500 s ... 30 s				•	•	M 39×0.75	41.8 mm	1.5 ... 3 mm	Control Unit

The new lens series HR Digaron-W/SW has been optimized for the larger sensor formats providing highest resolution above 80 megapixels with a pixel pitch around only 5 µm

HR Digaron-W/SW

[◀ Back to lens description](#)

Working apertures, image angles, image circles and movement ranges

Lens	Ref. image scale	Recomm. working aperture	Image angle	Image circle diameter	Movement range [mm] ²⁾ vertical/horizontal (landscape format)					
					24x36 mm	37x37 mm	33x44 mm	37x49 mm	36x56 mm	40x54 mm
32 mm f/4	1:∞	5.6-8	107°	90 mm	29 / 25	23 / 23	23 / 20	19 / 17	17 / 13	16 / 13
40 mm f/4	1:∞	5.6-8	94°	90 mm	29 / 25	23 / 23	23 / 20	19 / 17	17 / 13	16 / 13
50 mm f/4	1:∞	5.6-8	84°	90 mm	29 / 25	23 / 23	23 / 20	19 / 17	17 / 13	16 / 13
70 mm f/5.6	1:∞	5.6-8	70°	100 mm	35 / 31	28 / 28	28 / 25	25 / 22	23 / 19	22 / 19
90 mm f/5.6	1:∞	5.6-11	67°	120 mm	45 / 40	38 / 38	39 / 35	36 / 32	35 / 29	33 / 29

²⁾ These values apply to the recommended working aperture at the given scale; with increasing scale, image circle and movement ranges increase

Image circles (original size)

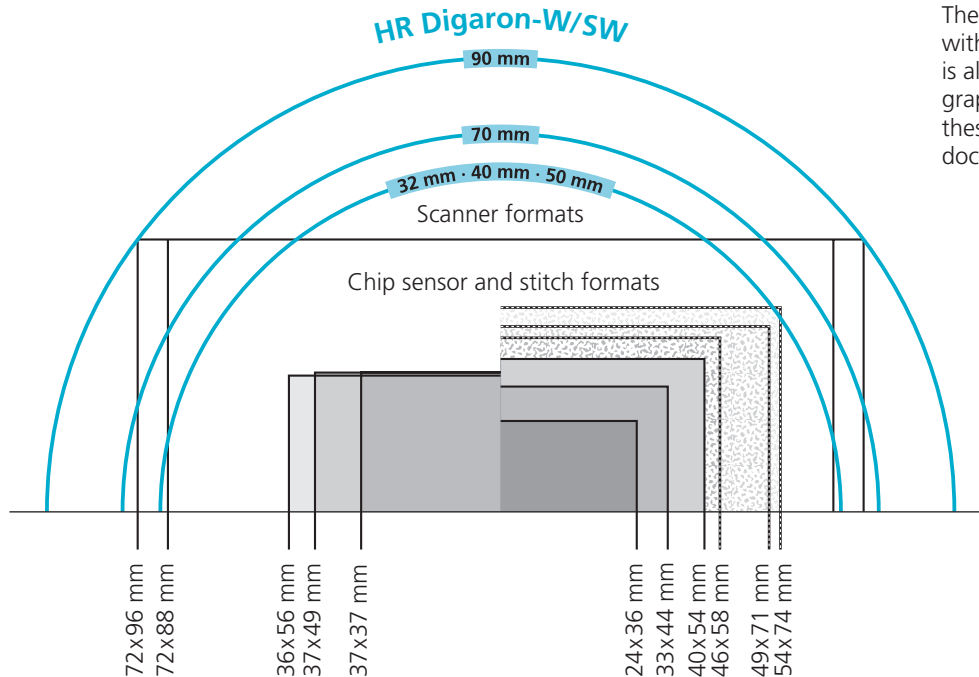

The lens HR Digaron-SW 90 mm f/5.6 with an image circle diameter of 120 mm is also recommended for digital photography with scanner backs. Above all, these backs are used for reproduction, documentation and library pictures.

With noticeable larger image circles than those of common digital lenses designed for 35 mm format sensors, now a totally new high-tech class of digital lenses has grown up

HR Digaron-W 32 mm f/4

[◀ Back to lens description](#)

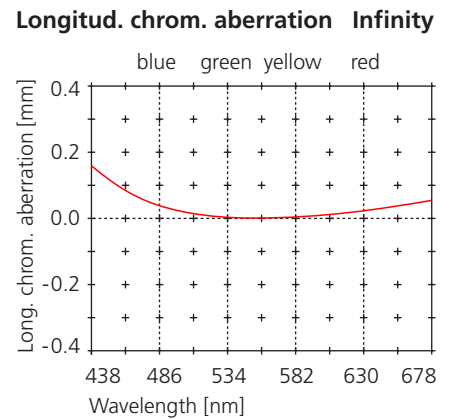
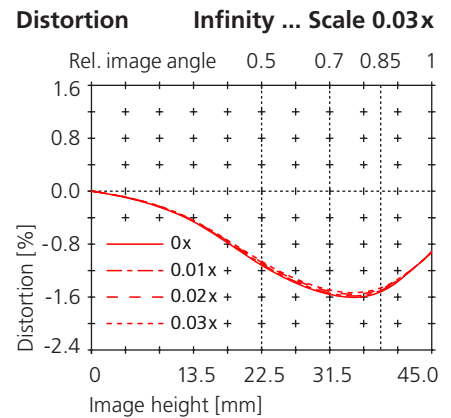
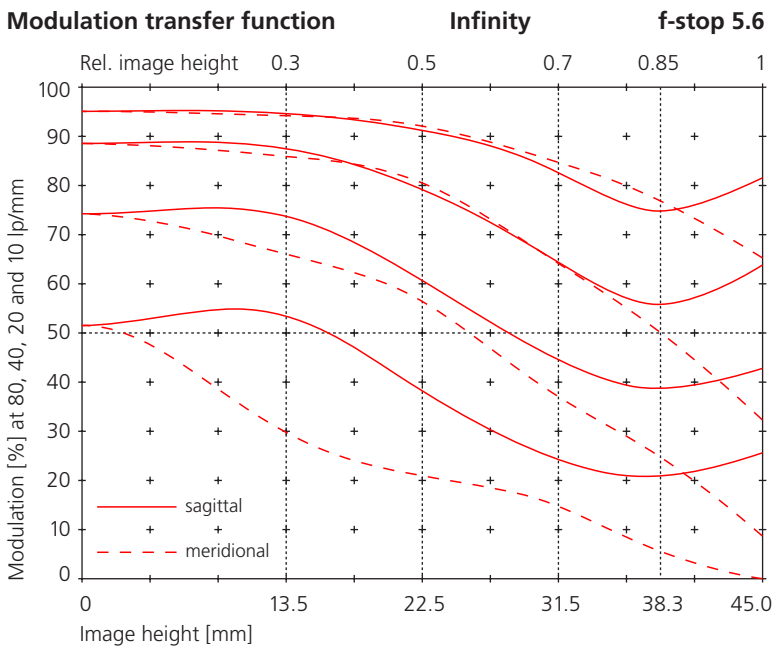
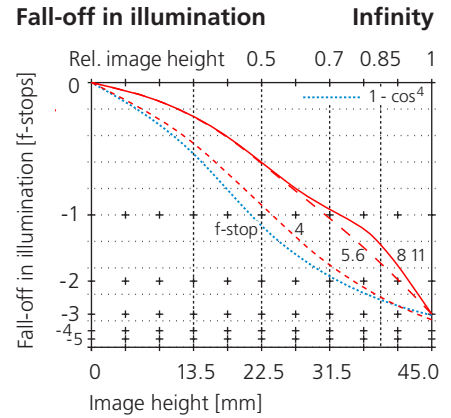
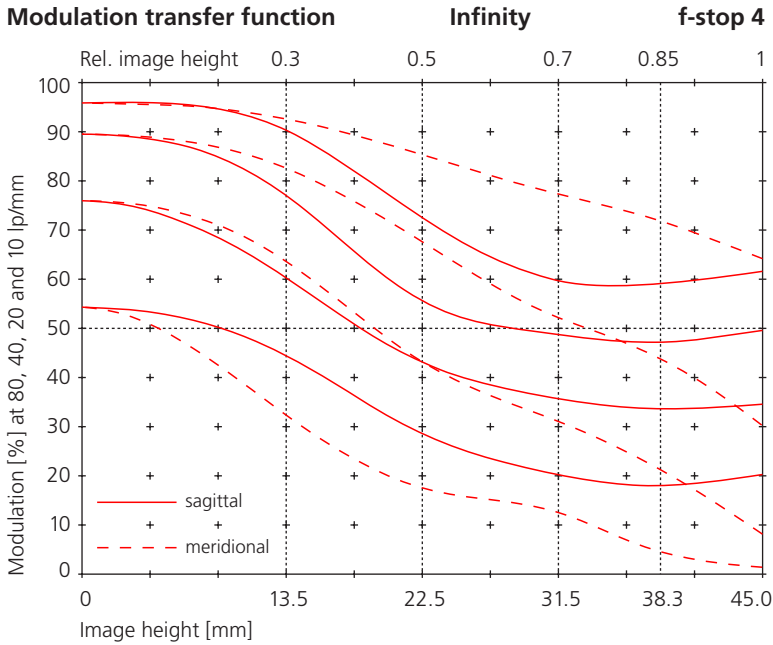

All spatial frequencies [line pairs/mm], image heights [mm] and scales are related to the film or sensor side

HR Digaron-W 40 mm f/4

[◀ Back to lens description](#)

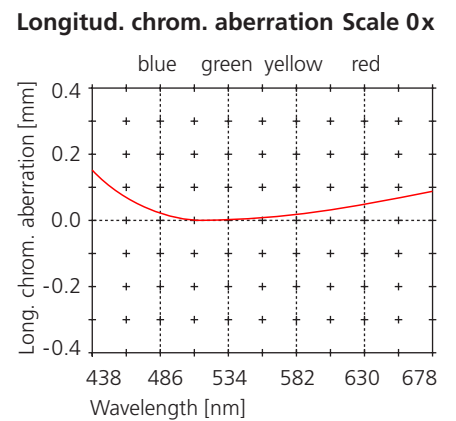
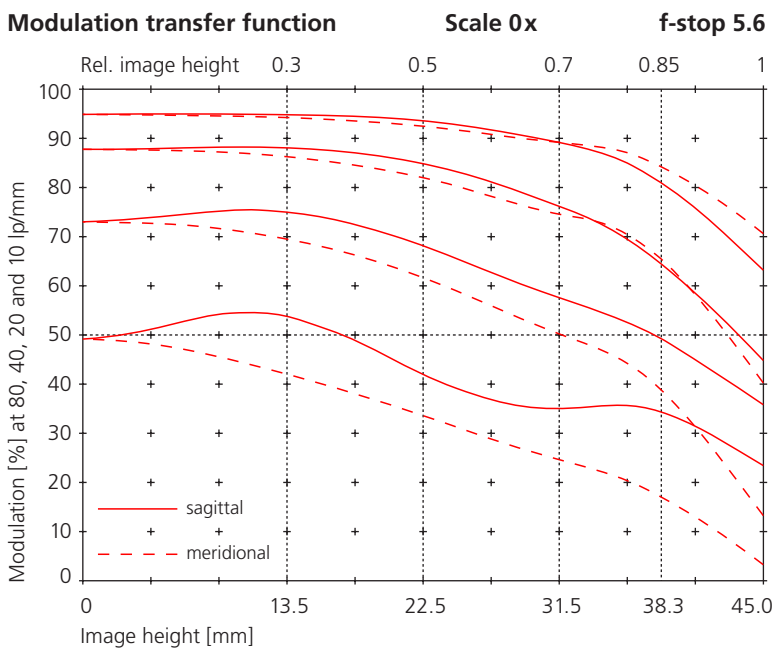
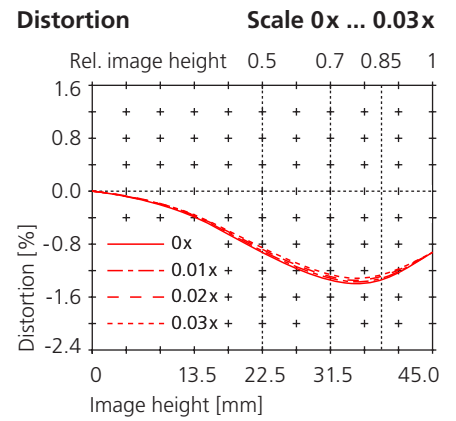
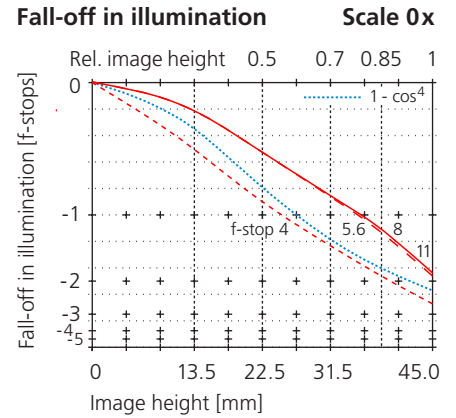
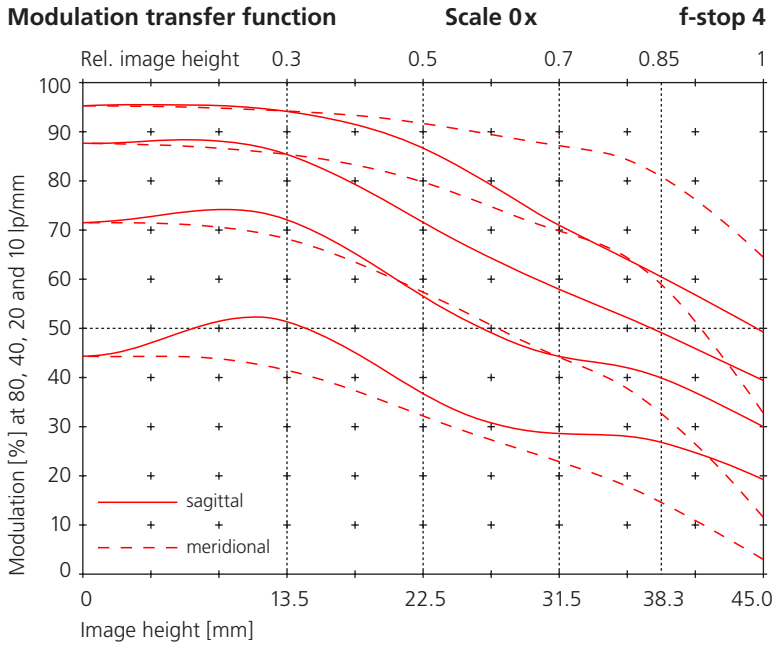

All spatial frequencies [line pairs/mm], image heights [mm] and scales are related to the film or sensor side

HR Digaron-W 50 mm f/4

[◀ Back to lens description](#)

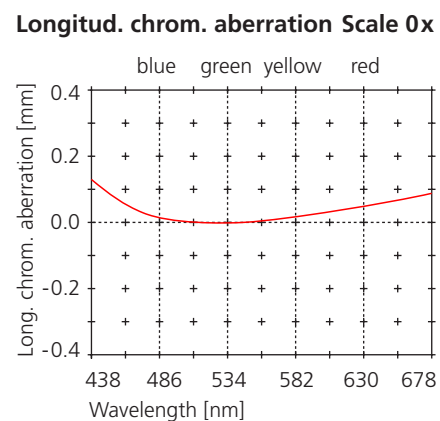
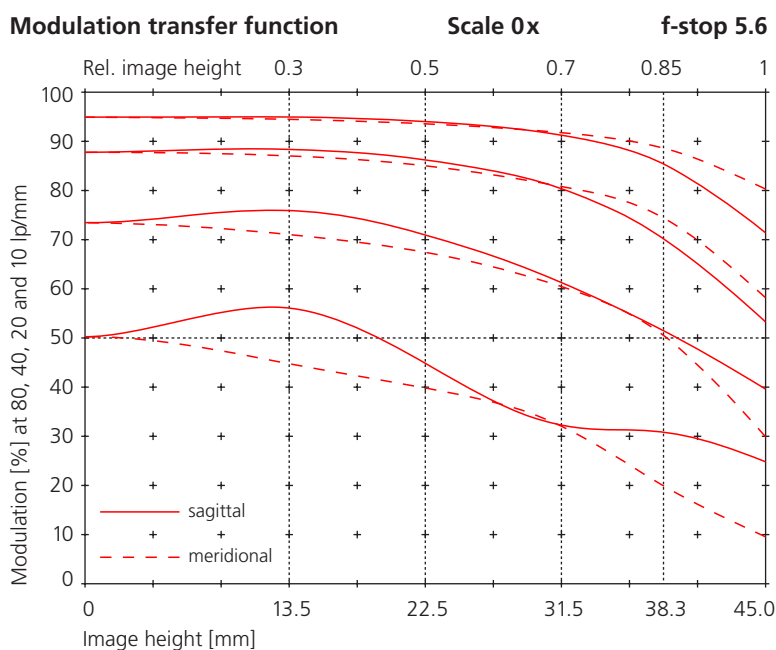
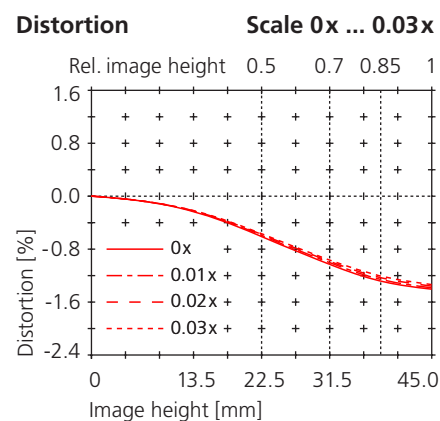
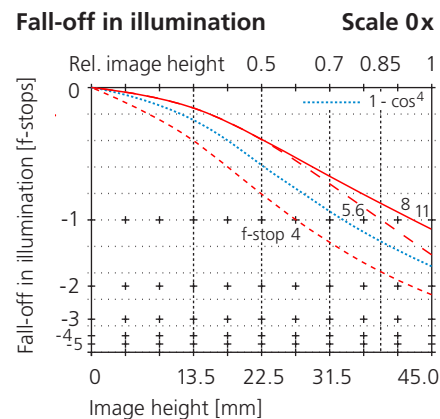
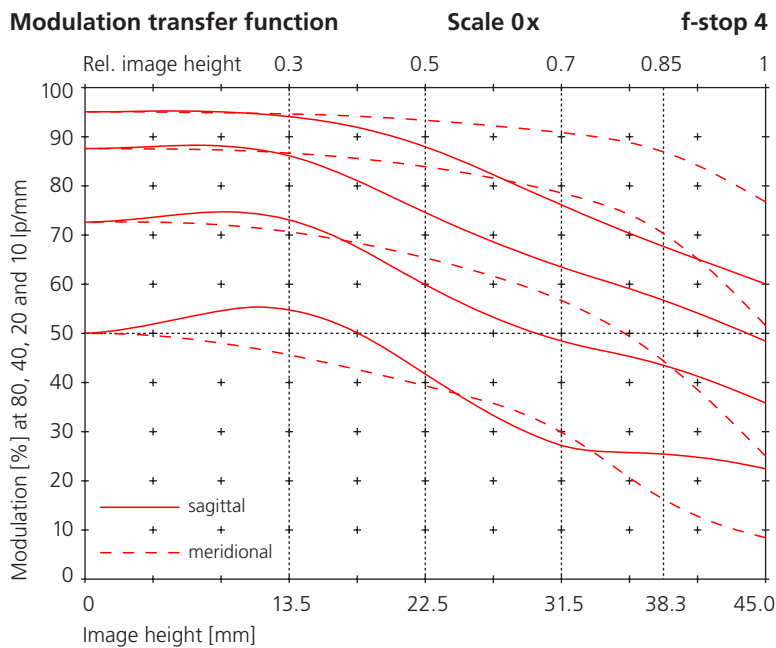

All spatial frequencies [line pairs/mm], image heights [mm] and scales are related to the film or sensor side

HR Digaron-W 70 mm f/5.6

[◀ Back to lens description](#)

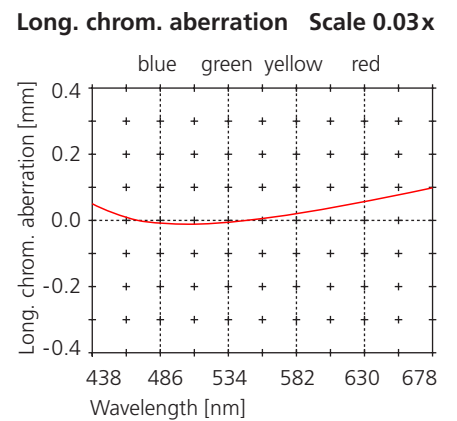
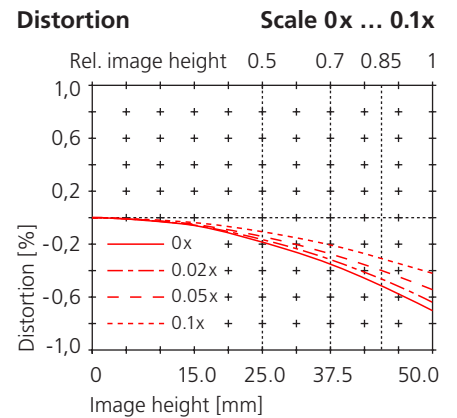
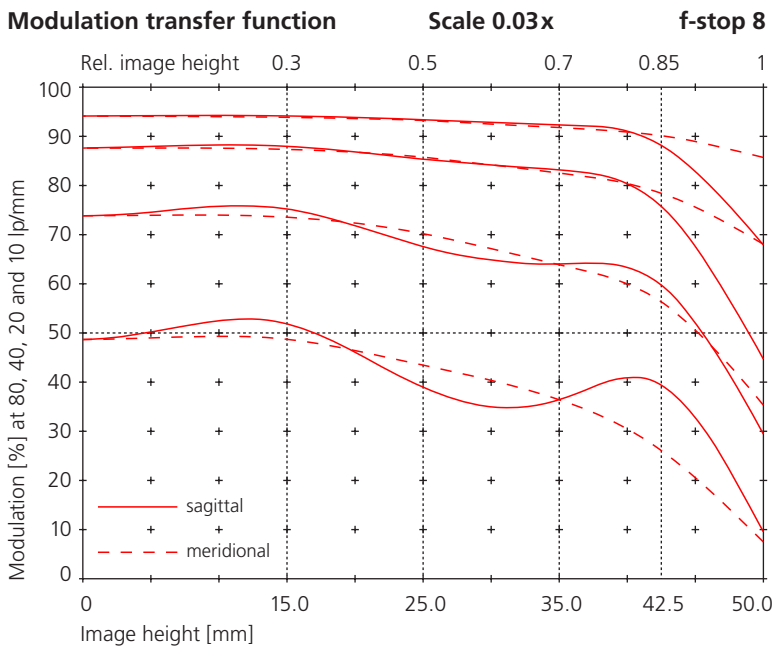
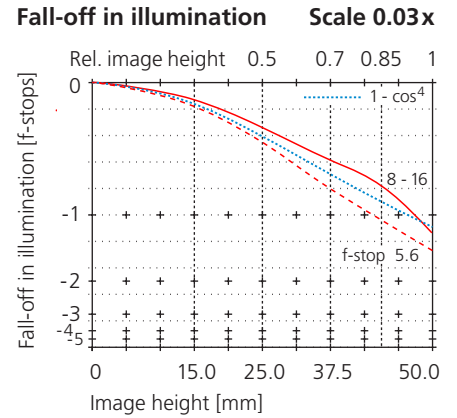
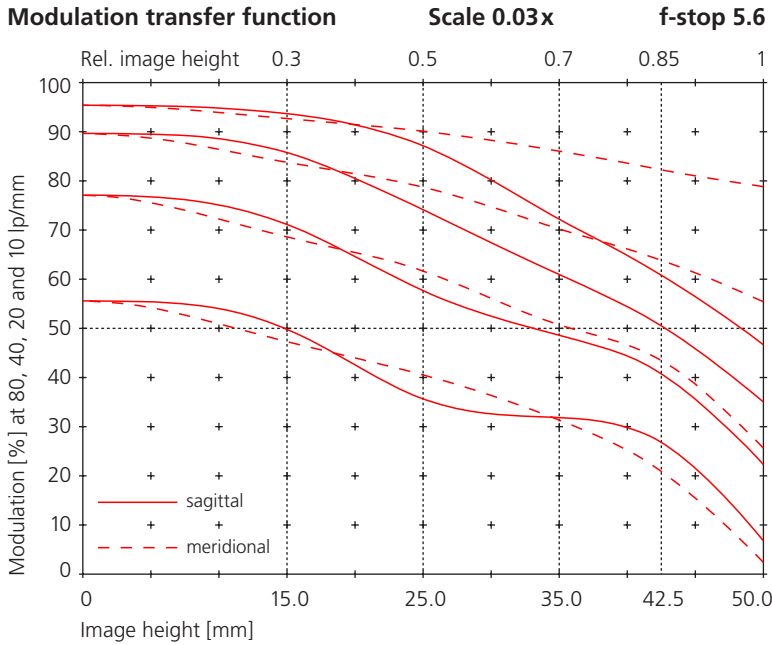

All spatial frequencies [line pairs/mm], image heights [mm] and scales are related to the film or sensor side

HR Digaron-SW 90 mm f/5.6

[◀ Back to lens description](#)

Modulation transfer function Infinity f-stop 4

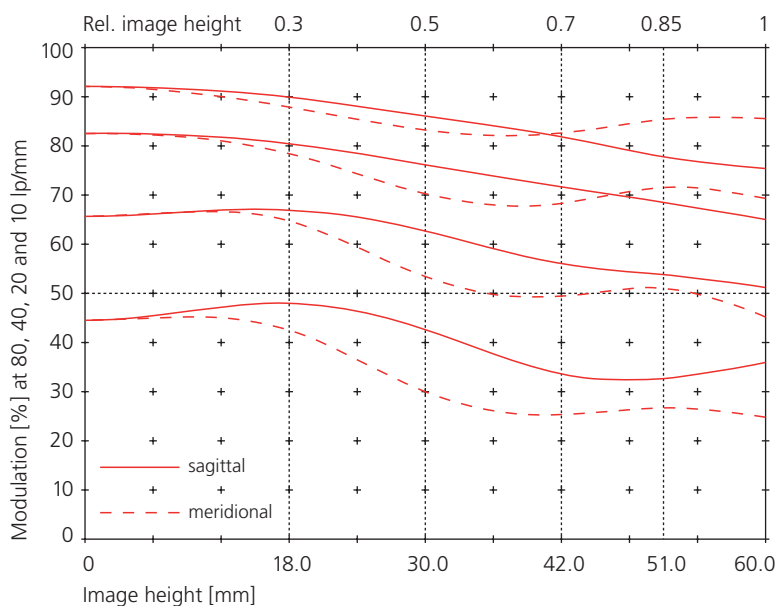

Fall-off in illumination Infinity

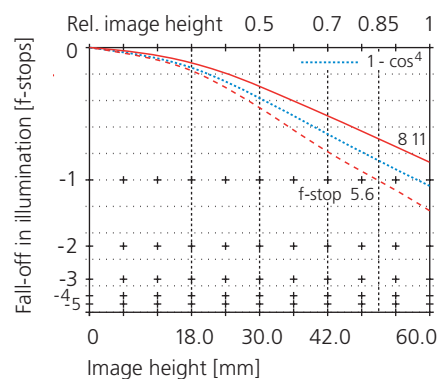

Modulation transfer function Infinity f-stop 5.6

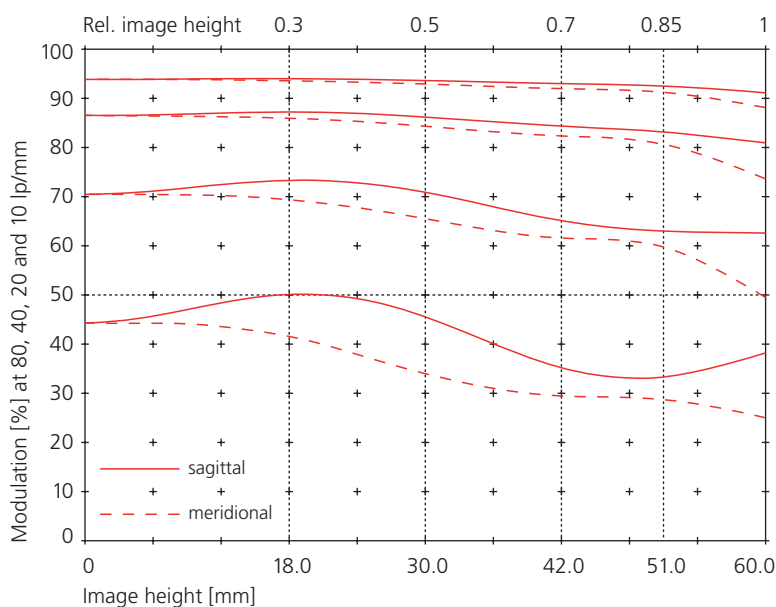

Distortion Infinity ... Scale 0.01x

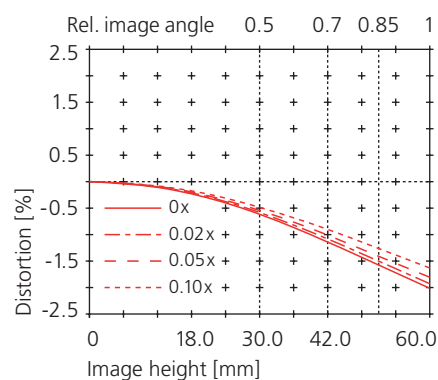

Longitud. chrom. aberration Infinity

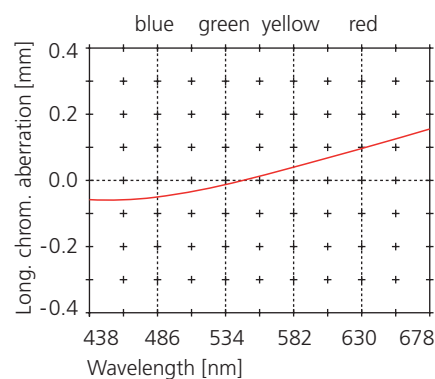

All spatial frequencies [line pairs/mm], image heights [mm] and scales are related to the film or sensor side

◀ [Back to digital photography](#)

- ▶ [HR Digaron-S](#)
- ▶ [HR Digaron-W/SW](#)
- ▶ **[Apo-Sironar digital](#)**
- ▶ **[Apo-Macro-Sironar digital](#)**
- ▶ [Accessories: Centerfilter](#)
- ▶ [Accessories: Focus-Mount](#)

Lenses for Digital Professional Photography

Apo-Sironar digital / Apo-Macro-Sironar digital

This line of lenses provides the photographer with even larger image circles for digital photos with adjustable professional cameras. They allow taking two and more laterally shifted overlapping photos for stitching as well as taking large-format photos with scanner backs. Focal lengths from 35 mm mean that real wide-angle shots are possible, even with area sensor sizes, while allowing large movements. The gap between the focal lengths 55 mm and 105 mm can be closed with the HR Digaron-W 70 mm and the HR Digaron-SW 90 mm lenses with image circles of 100 mm and 120 mm diameter respectively.

Due to the small formats on the one hand (which are sensitive to higher diffraction!) and the high illumination requirements of the CCD image sensor on the other, digital photography does not allow the lenses to be stopped down as much as in conventional large-format photography. As a result, these lenses have been optimized for a working aperture of 8 to 11. Because both the surface of the area sensors and the area scanned by the CCD line sensors have greater planarity than conventional roll and sheet films, special attention was given to the correction of the curvature of field. The freedom from distortion, which is so important for product and building photography, and the uniformity of illumination are also excellent.

The Apo-Macro-Sironar digital provides a special macro lens at the same superb performance level of the Rodenstock Apo-Sironar digital series for high-resolution digital photos at reproduction scales from 1:5 to 2:1.



Data sheets

- ▶ [Formats, dimensions, shutter data, image circles, movement ranges](#)
- ▶ [Performance data Apo-Sironar digital 35 mm f/4.5](#)
- ▶ [Performance data Apo-Sironar digital 105 mm f/5.6](#)

Apo-Sironar digital Max. recommended scanner format

35 mm f/4.5	54×74 mm	(Stitch format)
45 mm f/4.5	72×96 mm	
55 mm f/4.5	72×96 mm	
105 mm f/5.6	72×96 mm	
135 mm f/5.6	72×96 mm	
150 mm f/5.6	72×96 mm	
180 mm f/5.6	72×96 mm	

Apo-Macro-Sironar digital

120 mm f/5.6	72×96 mm
--------------	----------

**Apo-Sironar digital: sharp and brilliant,
with the best flatness of field,
free from color fringes and from distortion**

Rodenstock Photo Optics

a brand of Qioptiq Photonics GmbH & Co. KG

Apo-Sironar digital / Apo-Macro-Sironar digital

[◀ Back to lens description](#)

Formats, shutter sizes, dimensions, weight

Lens	Maximum stitch or scan format	Shutter size	Push-on mount Ø (a)	Filter thread (b)	Rear barrel Ø (c)	Flange foc. length 1) (d)	Flange to lens end (e)	Overall length (f)	Weight w/Copal
35 mm f/4.5	46×58 mm	0	70 mm	M 67×0.75	60.0 mm	43.2 mm	24.7 mm	58.8 mm	220 g
45 mm f/4.5	72×96 mm	0	70 mm	M 67×0.75	60.0 mm	55.5 mm	30.0 mm	70.5 mm	350 g
55 mm f/4.5	72×96 mm	0	70 mm	M 67×0.75	60.0 mm	67.6 mm	32.0 mm	73.8 mm	400 g
105 mm f/5.6	72×96 mm	0	51 mm	M 49×0.75	31.5 mm	100.0 mm	13.8 mm	48.6 mm	170 g
135 mm f/5.6	72×96 mm	0	51 mm	M 49×0.75	48.0 mm	132.0 mm	19.0 mm	53.6 mm	240 g
150 mm f/5.6	72×96 mm	0	51 mm	M 49×0.75	51.0 mm	147.0 mm	22.0 mm	57.4 mm	250 g
180 mm f/5.6	72×96 mm	1	70 mm	M 67×0.75	60.0 mm	177.0 mm	25.5 mm	65.2 mm	410 g
120 mm f/5.6	72×96 mm	0	51 mm	M 49×0.75	40.5 mm	236.0 mm	16.1 mm	49.8 mm	220 g

1) With Copal shutter for scale 1:∞,

Apo-Macro-Sironar digital 120 mm f/5.6 for scale 1:1

All lenses of the Apo-Sironar digital and Apo-Macro-Sironar digital series are available not only with the shutters given in the following table, but also with a normal mount (with 39 mm Leica thread) or alternatively (only in combination with Copal 0 shutter) with the "Focus-Mount" helical focuser. For focusing range and flange focal length with Focus-Mount, please see [next page](#).

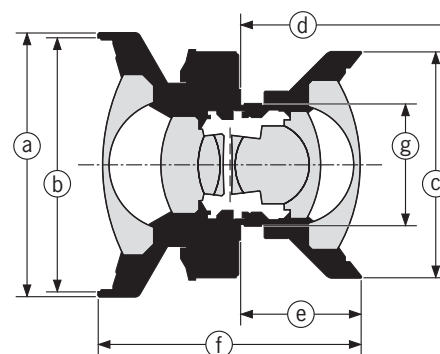

[▶ Continuation performance data](#)

Shutter type and size	Shutter speeds range	Shutter data					Screw thread (g)	Lens board opening	Lens board thickness	Accessories required
		Manual cocking	Self cocking	Mechanical	Electronic	X-synchronized				
Copal 0	B, T, 1/500 s ... 1 s	•	•	•	•	•	M 32.5×0,5	34.8 mm	1.5 ... 4 mm	
Copal 1	B, T, 1/400 s ... 1 s	•	•	•	•	•	M 39×0,75	41.8 mm	1.5 ... 3 mm	
Rodenst. eShutter 0	T, 1/125 s ... 32 s				•	•	M 32.5×0.5	34.8 mm	1.5 ... 4 mm	eShutter Control
Rollei Electron. 0	B, 1/500 s ... 30 s				•	•	M 39×0,75	41.8 mm	1.5 ... 3 mm	Control Unit
Rollei Electron. 1	B, 1/300 s ... 30 s				•	•	M 39×0,75	41.8 mm	1.5 ... 3 mm	Control Unit

The ideal high-performance lens for all who need digital photography as well as analog photography on roll film up to 6x9 cm (35 mm f/4.5 without camera movements)

Apo-Sironar digital / Apo-Macro-Sironar digital

[◀ Back to lens description](#)

Working apertures, image angles, image circles and movement ranges

Lens	Ref. image scale	Recomm. working aperture	Image angle	Image circle diameter	Movement range [mm] ²⁾ vertical/horizontal (landscape format)					
					37x49 mm	36x56 mm	40x54 mm	46x58 mm	72x88 mm	72x96 mm
35 mm f/4.5	1:∞	8-11	111°	105 mm	28 / 25	26 / 21	25 / 22	21 / 18		
45 mm f/4.5	1:∞	8-11	107°	125 mm	39 / 35	38 / 32	36 / 32	32 / 29	8 / 7	4 / 3
55 mm f/4.5	1:∞	8-11	95°	125 mm	39 / 35	38 / 32	36 / 32	32 / 29	8 / 7	4 / 3
105 mm f/5.6	1:∞	8-11	62°	125 mm	39 / 35	38 / 32	36 / 32	32 / 29	8 / 7	4 / 3
135 mm f/5.6	1:∞	8-11	58°	150 mm	53 / 48	52 / 45	50 / 45	46 / 42	25 / 22	21 / 18
150 mm f/5.6	1:∞	8-11	53°	150 mm	53 / 48	52 / 45	50 / 45	46 / 42	25 / 22	21 / 18
180 mm f/5.6	1:∞	8-11	45°	150 mm	53 / 48	52 / 45	50 / 45	46 / 42	25 / 22	21 / 18
120 mm f/5.6	1:5 - 2:1	8-11	55° - 24°	150 mm	53 / 48	52 / 45	50 / 45	46 / 42	25 / 22	21 / 18

²⁾ These values apply to the recommended working aperture at the given scale; with increasing scale, image circle and movement ranges increase

Focusing range and flange focal length with Focus-Mount

Lens	Focusing range	Flange foc. length ³⁾ ⓓ	Max. flange to lens end ⓔ
35 mm f/4.5	∞ - 0.4 m / 1.3 ft	24.5 mm	6.0 mm
45 mm f/4.5	∞ - 0.6 m / 2.0 ft	36.8 mm	11.3 mm
55 mm f/4.5	∞ - 0.9 m / 3.0 ft	48.9 mm	13.3 mm
105 mm f/5.6	∞ - 1.8 m / 6.0 ft	81.2 mm	0.0 mm
135 mm f/5.6	∞ - 3.0 m / 10.0 ft	112.7 mm	0.3 mm
150 mm f/5.6	∞ - 3.5 m / 11.5 ft	128.2 mm	3.3 mm

³⁾ With Copal shutter for scale 1:∞

Using digital lenses on cameras without bellows such as shift or panoramic cameras requires the use of the focusing facility Focus-Mount. It can be combined with all Rodenstock lenses in Copal shutter size 0. Existing lenses can be installed at a later date.

Bildkreise in Originalgröße ▶

The gap between the focal lengths 55 mm and 105 mm can be closed with the HR Digaron-W/SW 70 mm and 90 mm.

The exceptionally large image circles of the Apo-Sironar digital and Apo-Macro-Sironar digital allow photos with all sensors formats and scanner backs as well as stitching

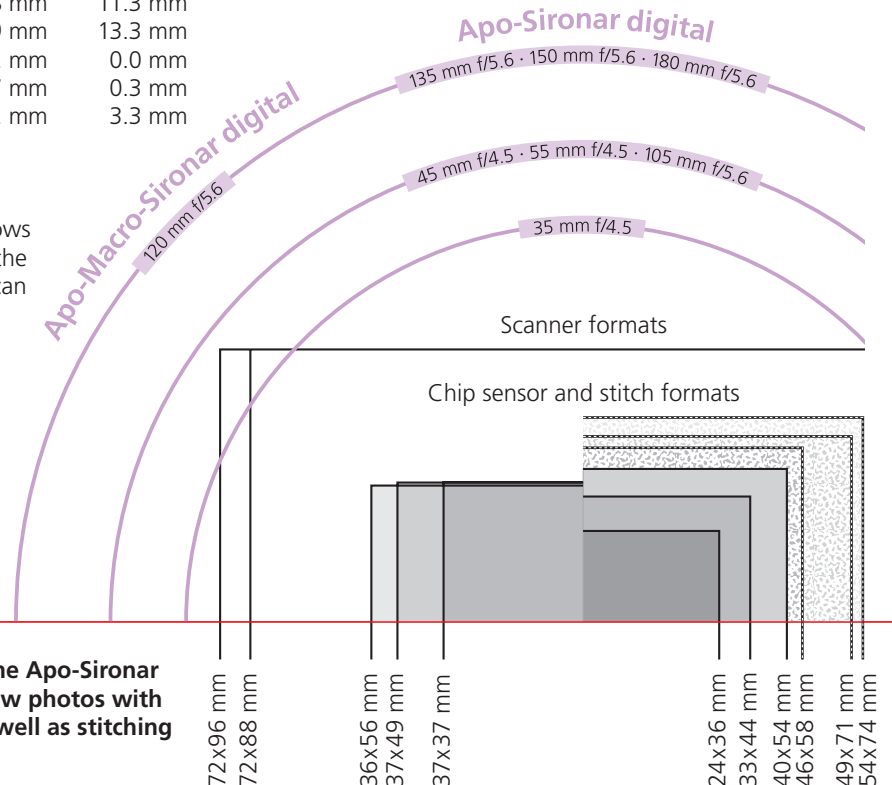

Apo-Sironar digital 35 mm f/4.5

[◀ Back to lens description](#)

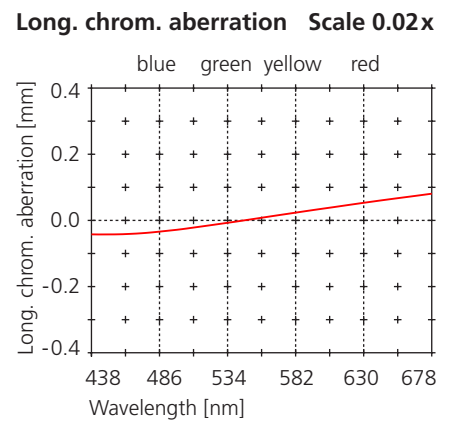
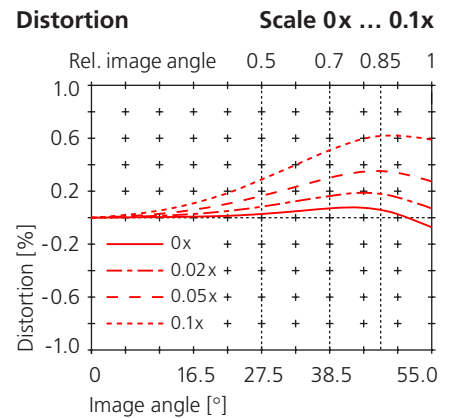
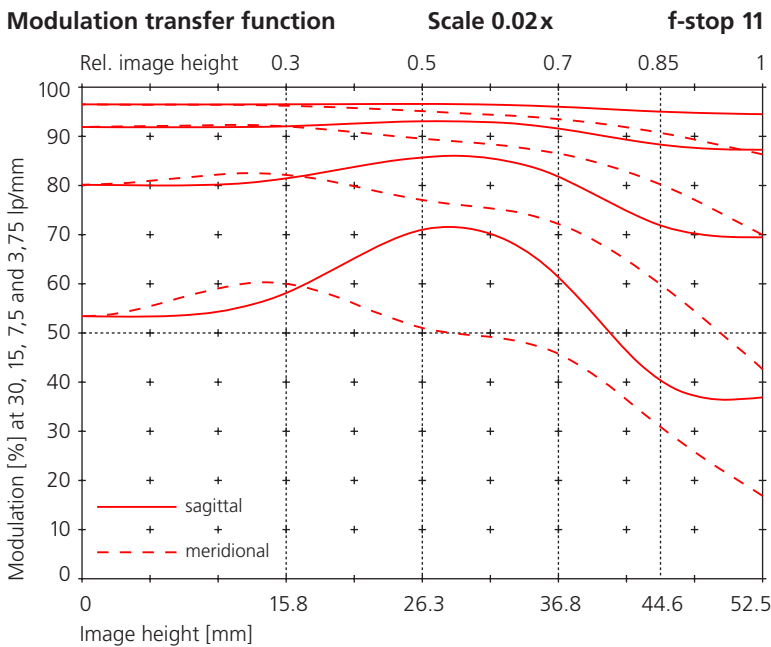
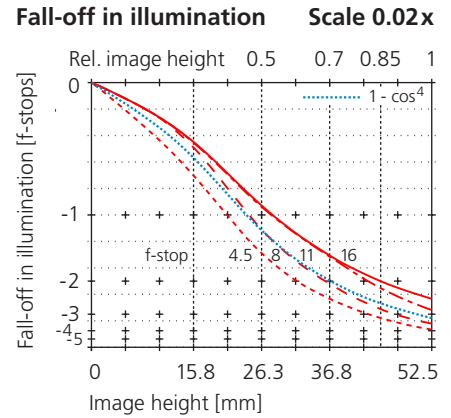
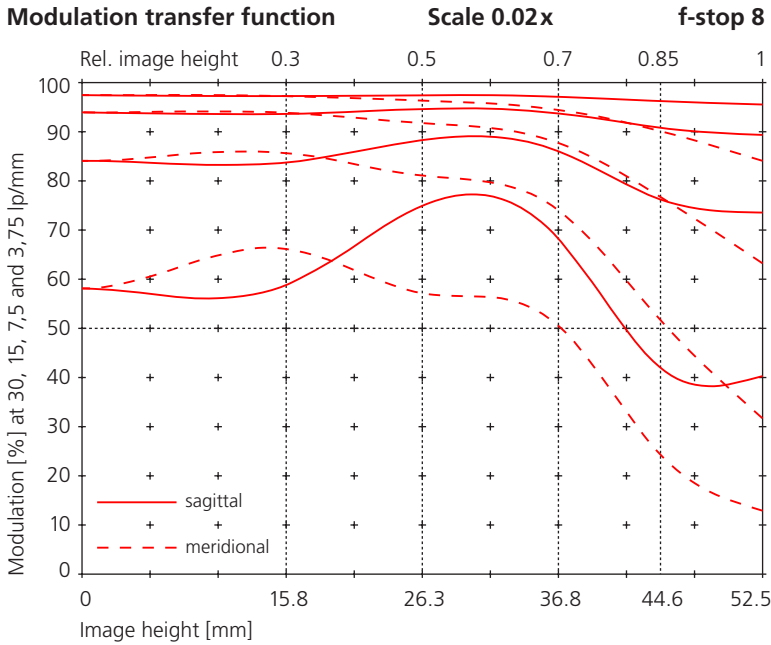

All spatial frequencies [line pairs/mm], image heights [mm] and scales are related to the film or sensor side

Apo-Sironar digital 105 mm f/5.6

[◀ Back to lens description](#)

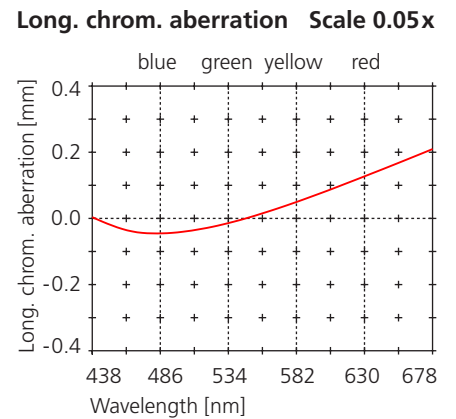
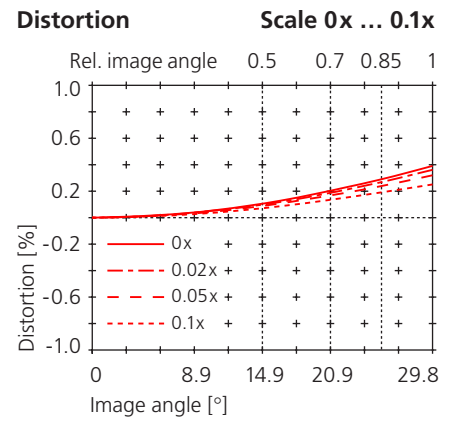
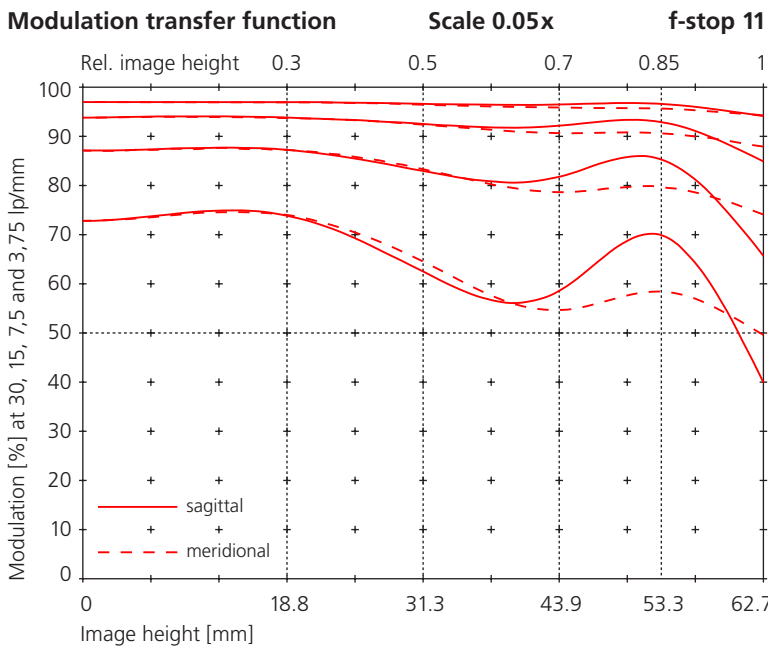
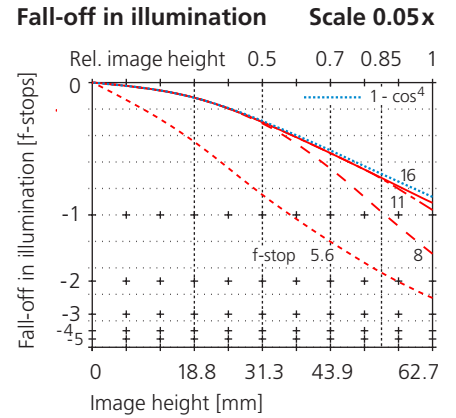
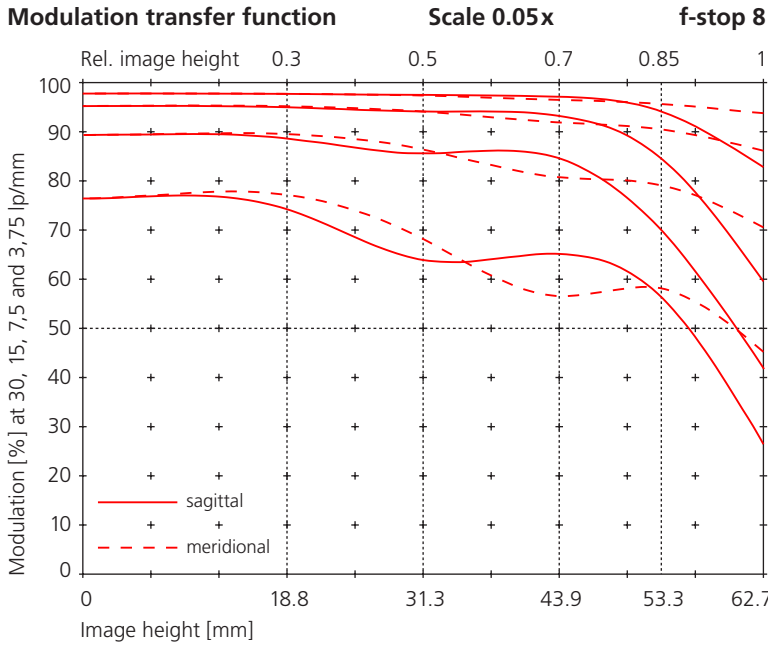

All spatial frequencies [line pairs/mm], image heights [mm] and scales are related to the film or sensor side

[◀ Back to digital photography](#)

- ▶ [HR Digaron-S](#)
- ▶ [HR Digaron-W/SW](#)
- ▶ [Apo-Sironar digital](#)
- ▶ [Apo-Macro-Sironar digital](#)

- ▶ **[Accessories: Center filter](#)**
- ▶ [Accessories: Focus-Mount](#)

Lenses for Digital Professional Photography

Accessories: Center filter

For critical shots (e. g. with areas of uniform brightness towards the image corners) the physically inevitable light fall-off according to the “cos⁴ law” may be visible and irritating. Digital photos can be lightened at the margin with imaging software like Photoshop®, but this does not help if the subjects at the margin are dark, because then they are underexposed and do not show any structure, color and depth. If they were lightened up then they get gray with a lot of image noise. However, the light fall-off can be eliminated by using the neutral gray Rodenstock center filters available for the HR Digaron-S 23 mm and 28 mm as well as for the HR Digaron-W 32 mm. A center filter should always be used if the image circle of is used right up to the vicinity of the circumference.

By utilizing an “optical trick” (tilting and increasing entrance pupil for larger incident angles with the optical axis), the light fall-off of the Rodenstock wide-angle lenses from 35 mm focal length on could be reduced almost to a level of lenses with a standard focal length. That's why no center filter is needed.

Rodenstock center filters are concentric graduated neutral gray filters whose density decreases from the center up to the transparent rim. The fall in density largely compensates for the light fall-off to the image edge from the recommended working f-stop. The remaining light fall-off is similar to that of lenses with longer focal lengths and does not irritate. Because of the density of the center filter the exposure must be corrected either by extended exposure time or by a wider aperture according to the table below.

Available for these lenses	Filter thread *	Exp. correction f-stop or time
HR Digaron-S 23 mm f/5.6	E 72/95	+2.5 EV x5,6
HR Digaron-S 28 mm f/4.5	E 72/95	+2.5 EV x5,6
HR Digaron-W 32 mm f/4	E 86/105	+2.5 EV x5,6

* The first number is the diameter of the rear male thread for fixing at the lens, the second number is the diameter of the front female thread for adding another filter or a lens hood.



Center filter: it compensates for the natural light fall-off of super wide-angle lenses according to the cos⁴ law

◀ [Back to digital photography](#)

- ▶ [HR Digaron-S](#)
- ▶ [HR Digaron-W/SW](#)
- ▶ [Apo-Sironar digital](#)
- ▶ [Apo-Macro-Sironar digital](#)

- ▶ [Zubehör: Centerfilter](#)
- ▶ **[Zubehör: Focus-Mount](#)**

Lenses for Digital Professional Photography

Accessories: Focus-Mount

Using Rodenstock digital lenses on cameras without bellows such as panoramic or shift cameras requires the use of a focusing facility: The Focus-Mount can be combined with all Rodenstock lenses in shutter size 0.

Existing lenses can be installed at a later date.

The Focus-Mount ensures precise focusing and the non-rotating lens mount means that all operating elements and scales of the shutter remain in the same position for best reading and handling. The Rodenstock digital lenses which can be used in the Focus-Mount as well as their focusing ranges can be found in the following table. For all lenses listed in this table the Focus-Mount is available with a distance scale (in meters and feet) adjusted to the respective focal length.

More information on applications and adaption of the Focus-Mount are available on request.



Digital lens		Focusing range
HR Digaron-S	23 mm f/5.6	∞ – 0.25 m
	28 mm f/4.5	∞ – 0.3 m
	35 mm f/4	∞ – 0.4 m
	60 mm f/4	∞ – 0.7 m
	100 mm f/4	∞ – 1.8 m
	180 mm f/5.6	∞ – 4.0 m
HR Digaron-W	32 mm f/4	∞ – 0.4 m
	40 mm f/4	∞ – 0.5 m
	50 mm f/4	∞ – 0.8 m
	70 mm f/5.6	∞ – 0.8 m
HR Digaron-SW	90 mm f/5.6	∞ – 1.3 m
Apo-Sironar digital	35 mm f/4.5	∞ – 0.4 m
	45 mm f/4.5	∞ – 0.6 m
	55 mm f/4.5	∞ – 0.9 m
	105 mm f/5.6	∞ – 1.8 m
	135 mm f/5.6	∞ – 3.0 m
	150 mm f/5.6	∞ – 3.5 m

Focus-Mount: it makes it possible to use the Rodenstock digital lenses on shift and panoramic cameras

Rodenstock Photo Optics
a brand of Qioptiq Photonics GmbH & Co. KG



Qioptiq Photonics GmbH & Co. KG
Rodestock Photo Optics
Hans-Riedl-Str. 9
D-85622 Feldkirchen (Muenchen)
Germany

Phone +49 (0)89 25 54 58-285
Telefax +49 (0)89 25 54 58-164
e-mail photo@qioptiq.de
Internet www.rodstock-photo.com

Rodestock Photo Optics is a brand of
Qioptiq Photonics GmbH & Co. KG, Feldkirchen (Munich), Germany